



USER MANUAL

for RUT550 LTE Router



Legal notice

Copyright © 2013 TELTONIKA Ltd. All rights reserved. Reproduction, transfer, distribution or storage of part or all of the contents in this document in any form without the prior written permission of TELTONIKA Ltd is prohibited. The manufacturer reserves the right to modify the product and manual for the purpose of technical improvement without prior notice.

Other product and company names mentioned herein may be trademarks or trade names of their respective owners.

Attention



Before using the device we strongly recommend reading this user manual first.



Do not rip open the device. Do not touch the device if the device block is broken.



All wireless devices for data transferring may be susceptible to interference, which could affect performance.



The device is not water-resistant. Keep it dry.



Device is powered by low voltage +9V DC power adaptor.

Table of Contents

Legal notice	2
Attention	2
SAFETY INFORMATION	5
Device connection	6
Introduction	7
Specifications:	7
LAN and Wi-Fi:	7
LTE	7
UMTS	7
GSM/GPRS/EDGE	7
Electrical, Mechanical & Environmental:	8
Applications	9
Setting up your router	10
Installation	10
Front Panel	10
Back Panel	11
SIM Card	11
Logging in	11
Operation Modes	16
Powering Options	17
Using terminal block for power input	18
Powering MVC300 cameras	20
Function explanations	22
Status	22
System Information	22
Network Information	23
Routes	27
Realtime Graphs	27
Network	33
LTE	33
Wan	34
LAN	40

Wireless	42
Backup WAN	45
Firewall.....	47
Static Routes	49
Diagnostics	50
Services	50
PING Reboot	50
SMS Reboot.....	51
Status via SMS.....	52
NTP.....	52
Dynamic DNS.....	53
Wireless hotspot.....	54
OpenVPN.....	57
IPsec	59
GRE Tunnel.....	61
Systems	63
Configuration Wizard.....	63
Administration	65
Administration properties	65
Backup and Firmware	66
Reboot.....	67
Logout	67
Glossary:	67

SAFETY INFORMATION

In this document you will be introduced on how to use a RUT550 router safely. We suggest you to adhere to the following recommendations in order to avoid personal injuries and or property damage.

You have to be familiar with the safety requirements before using the device!

To avoid burning and voltage caused traumas, of the personnel working with the device, please follow these safety requirements.



The device is intended for supply from a Limited Power Source (LPS) that power consumption should not exceed 15VA and current rating of overcurrent protective device should not exceed 2A.



The highest transient overvoltage in the output (secondary circuit) of used PSU shall not exceed 71V peak.



The device can be used with the Personal Computer (first safety class) or Notebook (second safety class). Associated equipment: PSU (power supply unit) (LPS) and personal computer (PC) shall comply with the requirements of standard EN 60950-1.



Do not mount or service the device during a thunderstorm.



To avoid mechanical damages to the device it is recommended to transport it packed in a damage-proof pack.



Protection in primary circuits of associated PC and PSU (LPS) against short circuits and earth faults of associated PC shall be provided as part of the building installation.

To avoid mechanical damages to the device it is recommended to transport it packed in a damage-proof pack. While using the device, it should be placed so, that its indicating LEDs would be visible as they inform in which working mode the device is and if it has any working problems.

Protection against overcurrent, short circuiting and earth faults should be provided as a part of the building installation.

Signal level of the device depends on the environment in which it is working. In case the device starts working insufficiently, please refer to qualified personnel in order to repair this product. We recommend forwarding it to a repair center or the manufacturer. There are no exchangeable parts inside the device.

Device connection

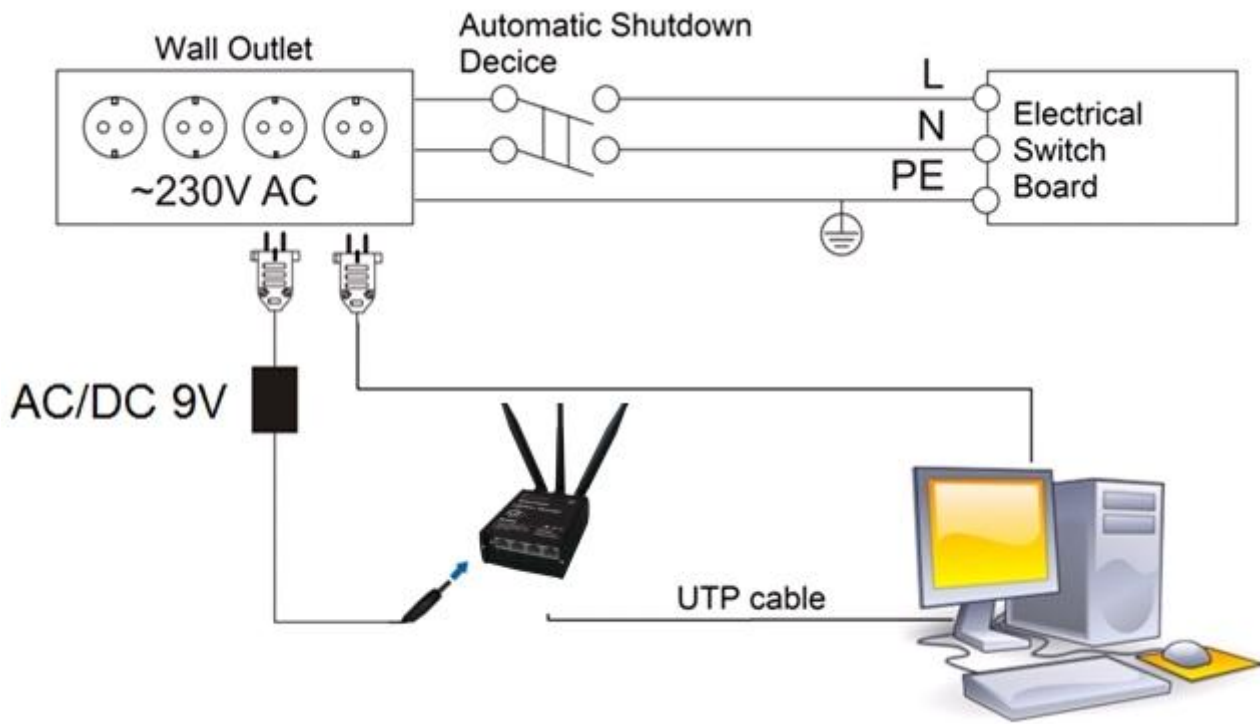

Introduction

Thank you for purchasing a RUT550 LTE router!

RUT550 is part of the RUT5xx series of compact mobile routers with high speed wireless and Ethernet connections. This router is ideal for people who'd like to share their internet on the go, as it is not restricted by a cumbersome cable connection. Unrestricted, but not forgotten: the router still supports internet distribution via a broadband cable, simply plug it in to the wan port, set the router to a correct mode and you are ready to browse.

Specifications:

LAN and Wi-Fi:

- Wireless AP, Router, 4-Port Switch and Firewall in one device
- High performance 320 MHz CPU with 256 Mbits SDRAM
- IEEE 802.11b/g/n, IEEE 802.3, IEEE 802.3u standards
- 64/128-bit WEP, WPA, WPA2, WPA&WPA2 encryption methods
- 3xLAN 10/100Mbps Ethernet ports
- 1xWAN 10/100Mbps Ethernet port
- Supports Auto MDI/MDIX
- Remote/local Web management
- 1x 5dBi wireless antenna
- SSID stealth mode and access control based over MAC address
- System log to record the status of the Router
- Auto negotiation/manual mode for IEEE 802.11b/g/n
- Dynamic DNS
- LAN access control over Internet connection
- Virtual server
- Auto wireless channel selection
- OpenVPN
- Backup WAN
- IPSec
- SMS and Ping reboot
- Din rail mounting (optional)
- Power over Ethernet (WAN and LAN)

LTE

- FDD 800/850/900/1800/1900/2100/2600 MHz
- Up to 100 Mbps downlink speed
- Up to 50 Mbps uplink speed
- All bands with diversity
- 2 dBi LTE/UMTS/GMS antenna

UMTS

- 850/900/1900/2100 MHz
- DC-HSPA+ mode: DL up to 43.2 Mbps, UL 5.76 Mbps
- HSPA+ mode: DL up to 21.6 Mbps, UL 5.76 Mbps
- UMTS mode: 384 kbps DL/384 kbps UL
- All bands with diversity

GSM/GPRS/EDGE

- 850/900/1800/1900 MHz
- Power Class 4 (2 W, 33 dBm) GSM/GPRS 850/900 MHz

- Power Class 1 (1 W, 30 dBm) GSM/GPRS 1800/1900 Mhz
- Power Class E2 (0.5 W, 27 dBm) for EDGE 850/900 MHz
- GPRS: 85.6 kbps DL/85.6 kbps UL (class 12)
- EDGE: 236.8 kbps DL/236.8 kbps UL (class 12)

Electrical, Mechanical & Environmental:

- Dimensions (H x W x D) 100mm x 85mm x 36mm
- Weight 210g
- Power Supply 100 – 240 VAC -> 9 VDC wall adapter
- Input voltage range: 7 – 30VDC (**8 – 18 VDC for older revision***)
- Power Consumption < 7W
- Antenna connectors 2 x SMA for LTE, 1 x RP-SMA for WiFi
- Indicators 4 x Ethernet LEDs, 1 x Power LED, 1 x LTE LED
- Operating Temperature 0C to +50C
- Storage temperature -20C to +70C
- Operating Humidity 10% to 90% Non-condensing
- Storage humidity 5% to 95% Non-condensing

Applications

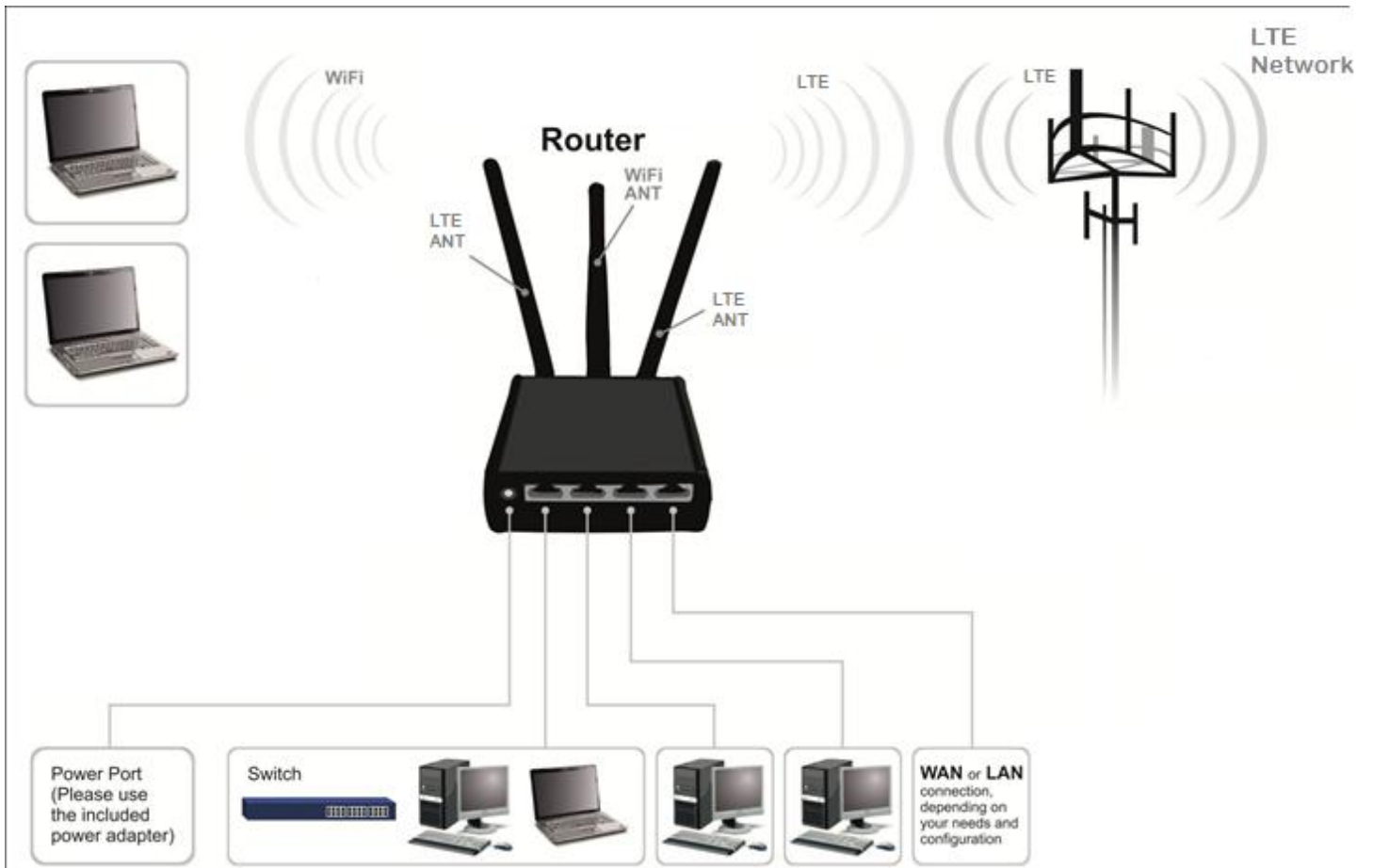

Setting up your router

Installation

After you unpack the box, follow the steps, documented below, in order to properly connect the device. For better Wi-Fi performance, put the device in clearly visible spot, as obstacles such as walls and door hinder the signal.

1. First assemble your router by attaching the necessary antennas and inserting the SIM card.
2. To power up your router, please use the power adapter included in the box. (IMPORTANT: Using a different power adapter can damage and void the warranty for this product.)
3. If you have a wired broadband connection you will also have to connect it to the WAN port of the router.

Front Panel

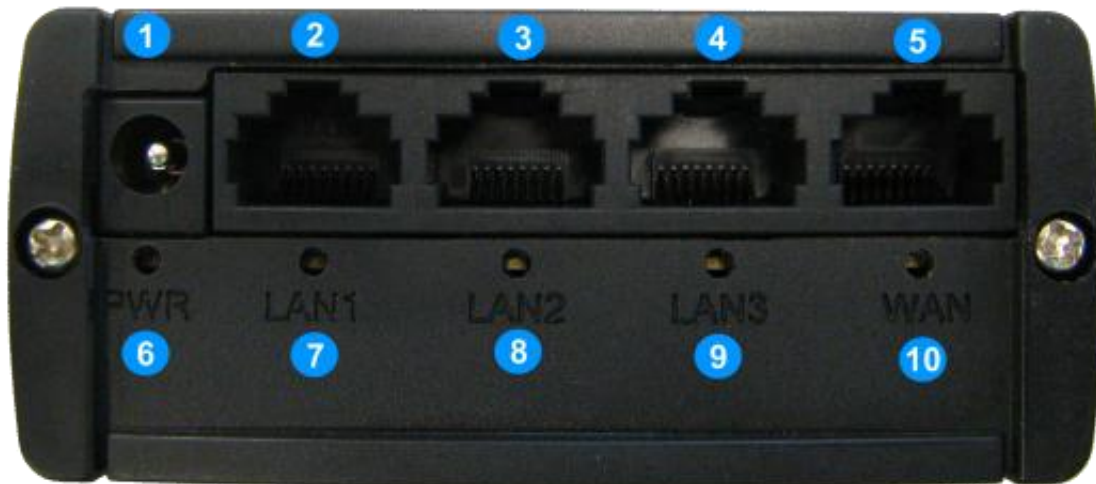

1	Power socket
2,3,4	LAN Ethernet ports
5	WAN Ethernet ports
6	Power LED
7,8,9	LAN LEDs
10	WAN LED

Back Panel



1	GSM (LTE) main antenna connector
2	Wi-Fi antenna connector
3	GSM (LTE) auxiliary antenna connector (unavailable on alternate model)
4	Reset button
5	GSM LED

SIM Card

1. Remove back panel and insert SIM card which was given by your ISP (Internet Service Provider). Correct SIM card orientation is shown in the picture.

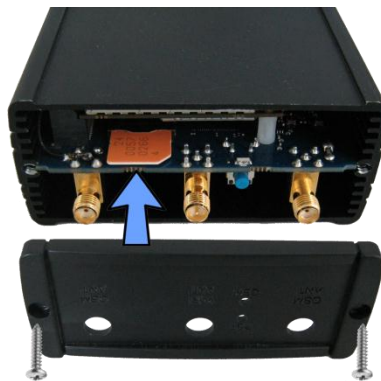

2. Attach GSM (LTE) main and Wi-Fi antennas.
3. Connect the power adapter to the socket on the front panel of the device. Then plug the other end of the power adapter into a wall outlet or power strip.
4. Connect to the device wirelessly (SSID: **Teltonika**) or use Ethernet cable and plug it into any LAN Ethernet port.

Logging in

After you're complete with the setting up as described in the section above, you are ready to start logging into your router and start configuring it. This example shows how to connect on Windows 7. On windows Vista: click Start -> Control Panel -> Network and Sharing Centre -> Manage network Connections -> (Go to step 4). On Windows XP: Click

Start -> Settings -> Network Connections -> (see step 4) -> You won't see "Internet protocol version 4(TCP/IPv4)", instead you'll have to select "TCP/IP Settings" and click options -> (Go to step 6)

We first must set up our network card so that it could properly communicate with the router.

1. Press the start button

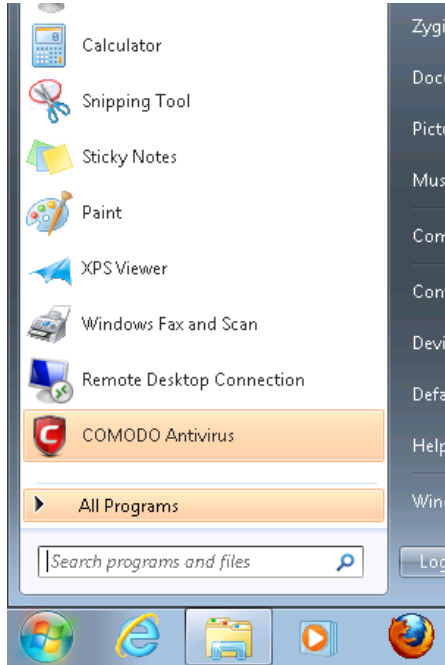

2. Type in "network connections", wait for the results to pop up.

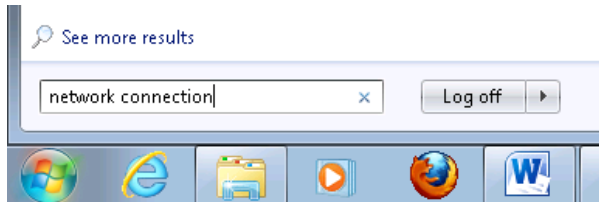

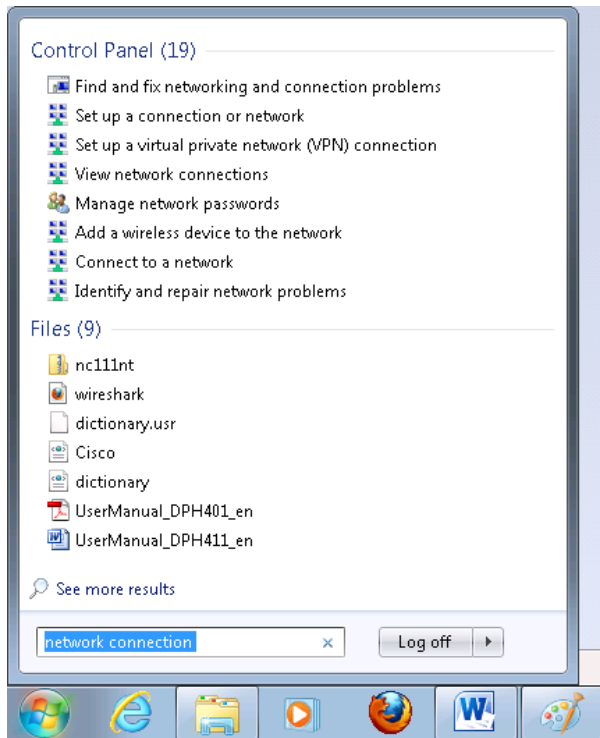

3. Click "View network connections"

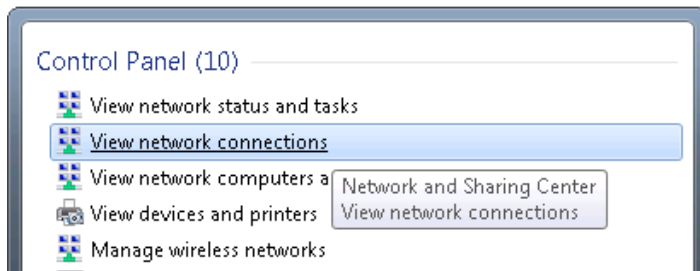

4. Then right click on your wireless device that you use to connect to other access points (It is the one with the name "Wireless Network Connection" and has signal bars on its icon).

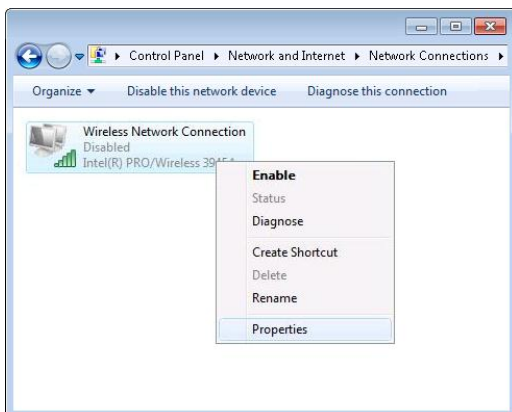

5. Select Internet Protocol Version 4 (TCP/IPv4) and then click Properties

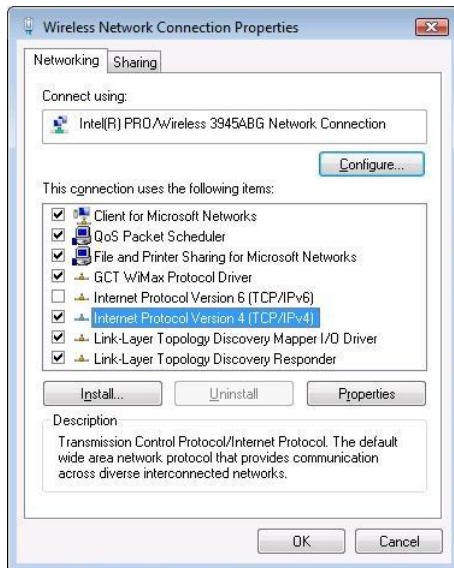

- By default the router is going to have DHCP enabled, which means that if you select “Obtain an IP address automatically” and “Obtain DNS server address automatically”, the router should lease you an IP and you should be ready to login.

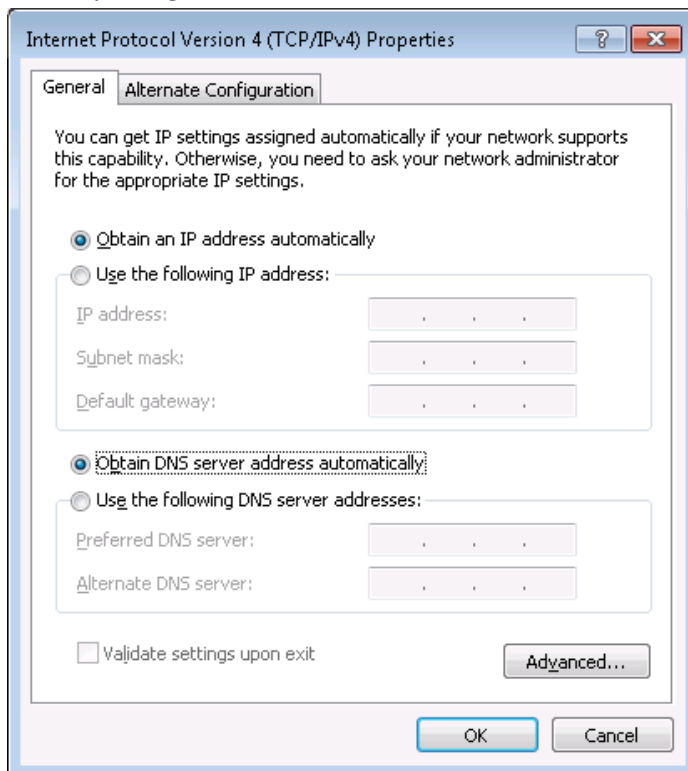

- If you choose to configure manually here’s what you do:
 First select an IP address. Due to the stock settings that your router has arrived in you can only enter an IP in the form of 192.168.1.XXX , where XXX is a number in the range of 2-254 (192.168.1.2 , 192.168.1.254 , 192.168.1.155 and so on... are valid; 192.168.1.0 , 192.168.1.1 , 192.168.1.255 , 192.168.1.699 and so on... are not). Next we enter the subnet mask: this has to be “255.255.255.0”. Then we enter the default gateway: this has to be “192.168.1.1”. Finally we enter primary and secondary DNS server IPs. One will suffice, though it is good to have a secondary one as well as it will act as a backup if the first should fail. The DNS can be your routers IP (192.168.1.1), but it can also be some external DNS server (like the one Google provides: 8.8.8.8).

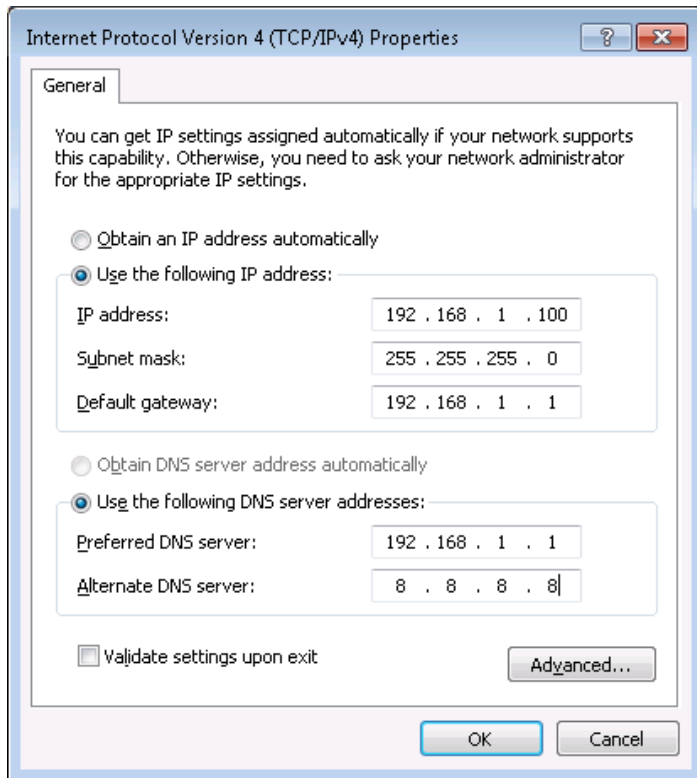

Right click on the Wireless network icon and select **Connect / Disconnect**. A list should pop up with all available wireless networks. Select “Teltonika” and click **connect**.



Then we launch our favourite browser and enter the routers IP into the address field:



Press enter. If there are no problems you should be greeted with a login screen such as this:

Authorization Required

Please enter your username and password.

Username

Password

Teltonika solutions: www.teltonika.lt

Enter the default password, which is “admin01” into the “Password” field and then either click Login with your mouse or press the Enter key. You have now successfully logged into the router and should see the Status page.

System information

System

Router Name	Teltonika
Router Model	Teltonika RUT550
Firmware Version	RUT5XX_R_01.00.768
Kernel Version	3.2.15
Local Time	Wed Aug 8 13:10:47 2013
Uptime	1h 36m 51s
Load Average	0.18, 0.11, 0.13

Memory

Total Available	10476 kB / 30012 kB (34%)
Free	1672 kB / 30012 kB (5%)
Cached	6456 kB / 30012 kB (21%)
Buffered	2348 kB / 30012 kB (7%)

From here on out you can configure almost any aspect of your router.

Operation Modes

The RUT550 router supports various operation modes. It can be connected to the internet (WAN) via LTE, standard Ethernet cable or via a wireless network. If you connect to the internet via an Ethernet cable or Wi-Fi, you may also backup your connection with LTE for added stability. On every case except when you connect to the internet via Wi-Fi, you can distribute your internet via an Ethernet cable (3 ports) and/or a wireless network. When you connect via Wi-Fi, you cannot have Wi-Fi in your LAN.

WAN	LAN		4G (LTE) Backup link
	Ethernet	Wi-Fi	
4G (LTE)	√	√	x
Ethernet	√	√	√
Wi-Fi	√	x	√

In later sections it will be explained, bit by bit, how to configure your router to work in a desired mode.

Powering Options

The RUT550 router can be powered from power socket (1) or over Ethernet port. Depending on your network architecture you can use LAN 3 (2) or WAN (3) Ethernet port to power the device.



RUT550 can be powered either from power socket or either over Ethernet. **Do not connect power supplies to both power inputs simultaneously.**

Also do not use LAN3 and WAN port for powering RUT550 simultaneously.

Use pin 5 of Ethernet port to supply positive voltage and connect pins 7 and 8 ground. Even though only pin 5 is used in router for positive voltage input, there is a possibility to connect power supplies that uses both pins 4 and 5 for positive voltage. **To power RUT550 using LAN3 or WAN ethernet ports, please make sure, that all jumpers from the pins J4.1,J4.2, J3.1,J3.2 (show in a picture below) are removed, because there is a great risk of damaging a power supply!**

To check if the jumpers were mounted, you need to remove front panel (the one with power socket).

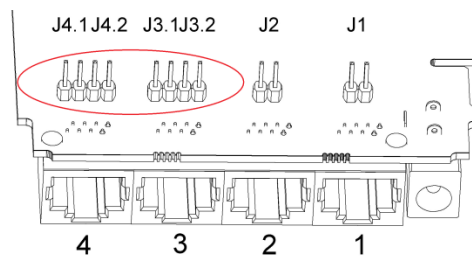

Pin	Signal ID	T568A Color	T568B Color	Pins on plug face (socket is reversed)
1	TX+	white/green stripe	white/orange stripe	
2	TX-	green solid	orange solid	
3	RX+	white/orange stripe	white/green stripe	
4		blue solid	blue solid	
5	7 - 30VDC	white/blue stripe	white/blue stripe	
6	RX-	orange solid	green solid	
7	GROUND	white/brown stripe	white/brown stripe	
8	GROUND	brown solid	brown solid	

Though the device can be powered over Ethernet port it is not compliant with IEEE 802.3af-2003 standard. Powering RUT550 from IEEE 802.3af-2003 power supply **will damage the device** as it is not rated for input voltages of PoE standard.

Using terminal block for power input

If you bought RUT550 with a 3.5mm contact pitch terminal block for power input instead of traditional 5.5x2.5mm power socket, below there is an instruction on how to power up router.

1. Loosen the screws on the top of the plug, so that the wires could fit into the plug holes. Use a screwdriver with a flat tip.

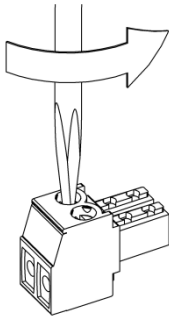

2. Strip the ends of the wires (strip length 5-6mm), then place the positive and negative wires into the plug as shown in the picture below. Make sure to use the same wire polarity like in the picture. Use wire size of 14-18 AWG (1.02-1.63mm in diameter).

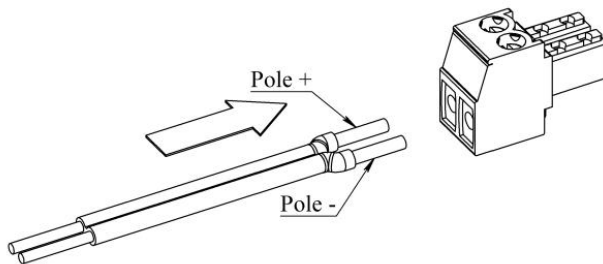

3. After wire is inserted, tighten the screws on the plug.

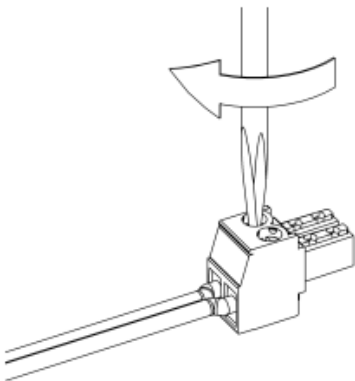

4. Insert the plug into the socket on the router:

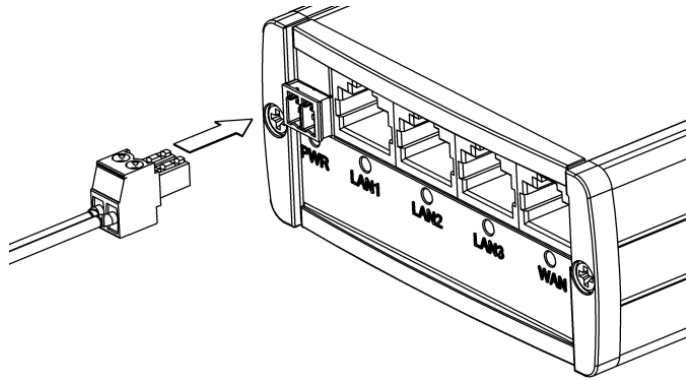

5. The other end of the wire needs to be connected to the power supply of your choice.
Recommended wattage of power supply:
≥9W (for powering only RUT550)
≥24W (for powering RUT550 and four MVC300 cameras connected to it)

In a RUT550+MVC300 solution, recommended power supply voltage is **≥12V**, especially when cameras are far away from RUT550, connected with long RJ45 cables.

Powering MVC300 cameras

All RUT550 ethernet ports have the ability to supply power for the connected MVC300 cameras using ethernet port pins 4 and 5 (4 is connected to ground, 5-positive voltage). To supply power for the connected MVC300 camera(s) from RUT550, first you need to remove the front and back panels, then take the PCB out of the metal enclosure. Now place a jumper on the contact pins associated with the LAN port that you connect your camera to. By default, all the jumpers are removed.

Port 1 - place jumper on contacts J1

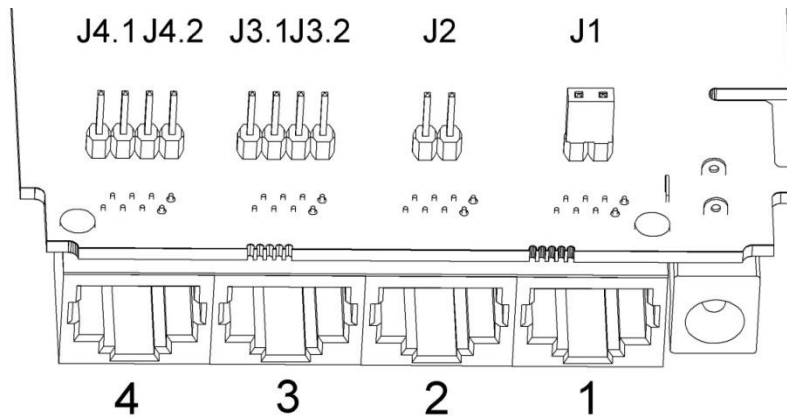

Port 2 - place jumper on contacts J2

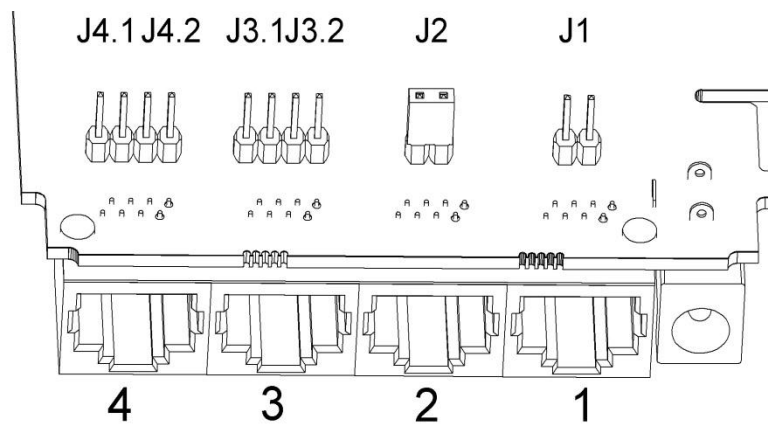

Port 3 - place jumpers on J3.1 and J3.2

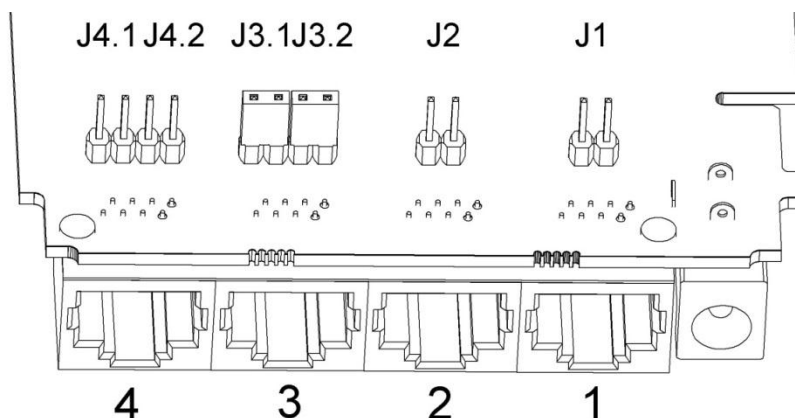

Port 4 - place jumpers on J4.1 and J4.2

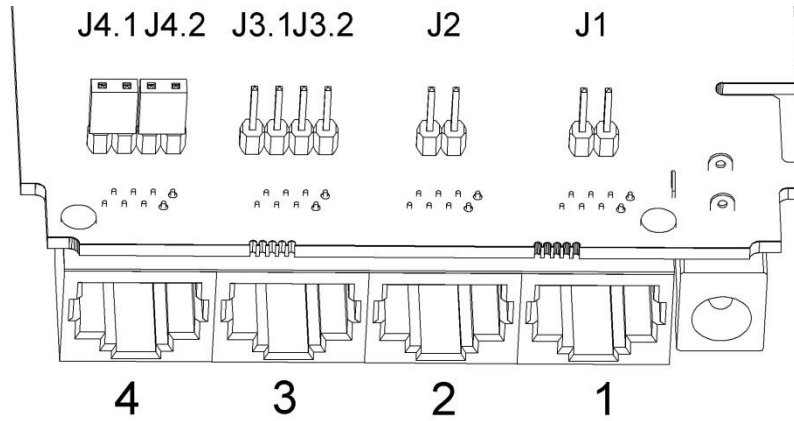

If all router LAN ports are to be used to connect MVC300 cameras, mount all 6 jumpers.

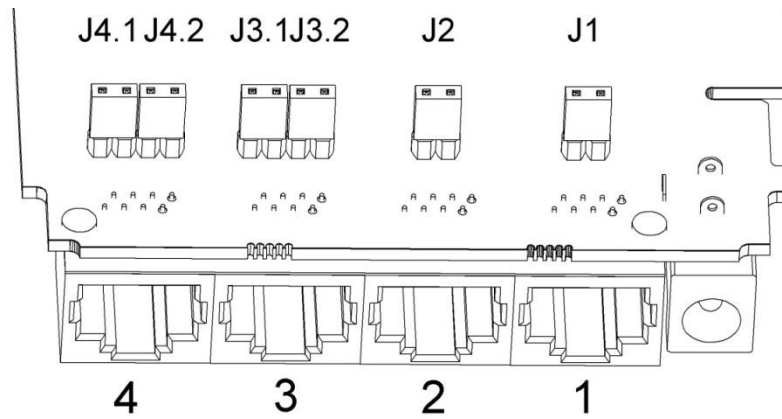

When a jumper is mounted, the associated LAN port is dedicated only for connecting MVC300 camera. Do not connect a PC or any other device, as there is a great risk for damaging them.

If you wish to connect PC, first please make sure that all of the jumpers associated to that port are removed.

Function explanations

The following sections contain a detailed explanation of every page, tab and sub tab of the configuration interface in the order that they appear on the router.

Status

The status section contains various information, like current IP addresses of various network interfaces; the state of the routers memory; firmware version; DHCP leases; associated wireless stations; graphs indicating load, traffic, etc.; and much more.

System Information

The System Information tab contains data that pertains to the routers operating system.

System

	Field Name	Sample value	Explanation
1.	Router Name	Teltonika	Name of the router (hostname of the routers system).
2.	Router Model	Teltonika RUT550	Routers model.
3.	Firmware Version	RUT5XX_R_01.00.768	Shows the version of the firmware that is currently loaded in the router. Newer versions might become available as new features are added. Use this field to decide whether you need a firmware upgrade or not.
4.	Kernel Version	3.2.15	The version of the Linux kernel that is currently running on the router.
5.	Local Time	Wed Aug 8 13:10:47 2013	Shows the current system time. Might differ from your computer, because the router synchronizes it's time with an NTP server.
6.	Uptime	1h 36m 51s	Indicates how long it has been since the router booted up. Reboots will reset this timer to 0.
7.	Load Average	0.98, 0.57, 0.30	Indicates how busy the router is. Let's examine some sample output: "2.43, 2.96, 3.41". The first number 2.43 means that in the past minute there have been, on average, 2.43 processes running or waiting for a resource. The second number show that in the past 10 minutes, on average, there have been 2.96 processes running or waiting for a resource. The last number indicates the same on the last 15 minutes.

Memory

	Field Name	Sample Value	Explanation
1.	Total Available	14416/29964	Shows how much memory is available to maintain routers functionality.
2.	Free	1476/29964	The amount of memory that is completely free. Should this rapidly decrease or get close to 0, it would indicate that the router is running out of memory, which could cause crashes and unexpected reboots.
3.	Cached	9868/29964	The size of the area of memory that is dedicated to storing frequently accessed data.
4.	Buffered	3072/29964	The size of the area in which data is temporarily stored before moving it to another location.

Network Information

This page is much like the status page, previously described, though dedicated to data associated with networking.

LTE

Statistics for the LTE modem and the connection.

LTE 	
State	connected
IMEI	860461024006424
Sim card state	OK
Signal strength	-73 dBm
Operator	OMNITEL LT Omnitel
Connection type	4G (LTE)
Bytes recieved	35547
Bytes sent	34429

	Field Name	Explanation
1.	State	Shows the state of the connection.
2.	IMEI	Shows the LTE modems IMEI number.
3.	Sim card state	Indicates whether the SIM card is inserted or not.
6.	Signal strength	Indicates connection strength.
7.	Operator	Indicates the operator of the mobile network.
8.	Connection type	Indicates the connection type.
9.	Bytes received	How many bytes were received via LTE.
10.	Bytes sent	How many bytes were sent via LTE.

WAN

Statistics on the routers WAN connection.

WAN

Interface	3G-ppp
Type	LTE
IPv4 address	10.12.18.71
Netmask	255.255.255.255
Gateway	10.12.18.71
DNS 1	213.226.131.131
DNS 2	193.219.88.36
Connected	0h 40m 32s

	Field Name	Sample Value	Explanation
1.	Interface	LTE	Specifies through what medium the router is connecting to the internet. This can either be Wired, LTE or Wi-Fi.
2.	Type	DHCP	Specifies the type of connection. This can either be static, DHCP or PPPoE.
3.	IPv4 address	10.12.104.103	The IP address that the routers uses to connect the internet.
4.	Netmask	255.255.255.240	Indicates the networks netmask.
5.	Gateway	10.12.104.97	Indicates the default gateway, an address where traffic destined for the internet is routed to.
6.	DNS#	8.8.8.8	Domain name server(s).
7.	Expires	1h 57m 25s	The amount of time before the routers DHCP lease expires.
8.	Connected	0h 2m 2s	How long the connection has been successfully maintained.

LAN

LAN

IPv4 address	192.168.1.161
Netmask	255.255.255.0
Connected	0h 6m 14s

	Field Name	Sample Value	Explanation
1.	IPv4 address	192.168.1.161	Address that the router uses on the LAN network.
2.	Netmask	255.255.255.0	Indicates the networks netmask.
3.	Connected	0h 6m 14s	How long LAN has been successfully maintained.

Wireless

Wireless can work in two modes, AP or Client. AP is when the wireless radio is used to create an Access Point that other devices can connect to. Client is when the radio is used to connect to an Access Point via WAN.

Client

Wireless

SSID	teltonika_rnd_division_ap
Mode	Client
Channel	6 (2.44 GHz)
BSSID	C8:3A:35:02:FC:B0
Encryption	WPA2 PSK (CCMP)
Bit rate	65.0 MBit/s
Country	LT

	Field Name	Sample Value	Explanation
1.	SSID	teltonika_rnd_division_ap	The SSID that the AP, to which the routers is connected to, uses.
2.	Mode	Client	Connection mode – Client indicates that the router is a client to some local AP.
3.	Channel	6 (2.44 GHz)	The channel that the AP, to which the routers is connected to, uses. Your wireless radio is forced to work in this channel in order to maintain the connection.
4.	BSSID	C8:3A:53:02:FC:B0	The MAC address of the access points radio.
5.	Encryption	WPA2 PSK (CCMP)	The AP, to which the router is connected to, dictates the type of encryption.
6.	Bit rate	65.0 MBit/s	The physical maximum possible throughput that the routers radio can handle. Keep in mind that this value is cumulative - The bitrate will be shared between the router and other possible devices that connect to the local AP.
7.	Country	LT	Country code.

AP

Wireless

Signal quality	100%
SSID	Teltonika_demo
Mode	Master
Channel	6 (2.44 GHz)
BSSID	00:0C:43:30:50:38
Encryption	WPA2 PSK (CCMP)
Bit rate	1.0 MBit/s
Country	LT

	Field Name	Sample Value	Explanation
1.	Signal Quality	100%	The quality between routers radio and some other device that is connecting to the router. Will show 0% if no devices are trying to connect or are currently maintaining a connection.
2.	SSID	Teltonika_demo	The SSID that is being broadcast. Other devices will see this and will be able to use to connect to your wireless network.
3.	Mode	Master	Connection mode – Master indicates that you router is an access point.
4.	Channel	6 (2.44 GHz)	The channel which is used to broadcast the SSID and to establish new connections to devices.
5.	BSSID	00:0C:43:30:50:38	MAC address of your wireless radio.
6.	Encryption	WPA2 PSK (CCMP)	The type of encryption that the router will use to authenticate, establish and maintain a connection.
7.	Bit rate	1.0 MBit/s	The bitrate will be shared between all devices that connect to the routers wireless network.

8.	Country	LT	Country code.
----	---------	----	---------------

Additional note: MBit/s indicates the bits not bytes. To get the throughput in bytes divide the bit value by 8, for e.g. 54MBit/s would be 6.75MB/s (Mega Bytes per second).

Associated Stations

Outputs a list of all devices and their MAC addresses that are maintain a connection with your router right now.

This can either be the information of the Access Point that the router is connecting to in Client Mode OR a list of all devices that are connecting to the router in Access Point mode:

MAC-Address	Network	Signal	RX Rate	TX Rate
BC:76:70:FE:AC:45	Master "Teltonika_demo_ap"	-48 dBm	72.2 Mbit/s, MCS 7, 20MHz	43.3 Mbit/s, MCS 4, 20MHz
00:37:6D:C5:37:44	Master "Teltonika_demo_ap"	-70 dBm	52.0 Mbit/s, MCS 5, 20MHz	6.5 Mbit/s, MCS 0, 20MHz

DHCP Leases

If you have enabled a DHCP server this field will show how many devices have received an IP address and what those IP addresses are.

Hostname	IPv4-Address	MAC-Address	Leasetime remaining
android_68594c78df714b08	192.168.1.101	bc:76:70:fe:ac:45	11h 59m 40s

The picture above shows a DHCP lease for an Android phone that is currently connecting to the routers Access Point.

Backup WAN

When enabled this field will indicate the health of your primary connection:

IN USE	Indicates that the connection is being used for main traffic.
READY	Indicates that the connection is ready to take over network traffic, if the other link should fail.
NOT READY	Indicates that the connection is down.

Backup WAN Status

WAN: [Wired] IN USE Backup WAN: [LTE] READY

Backup WAN Status

WAN: [Wired] NOT READY Backup WAN: [LTE] IN USE

More on this see the main backup WAN section of this manual.

Routes

Routes

The following rules are currently active on this system.

ARP

IPv4-Address	MAC-Address	Interface
192.168.0.30	70:71:bc:0c:f9:f5	br-lan
192.168.99.254	00:00:00:00:00:00	eth0.2

Active IPv4-Routes

Network	Target	IPv4-Gateway	Metric
wan	0.0.0.0/0	192.168.99.254	0
lan	192.168.0.0/24	0.0.0.0	0
wan	192.168.99.0/24	0.0.0.0	0

Teltonika solutions: www.teltonika.lt

ARP

Shows the routers active ARP table. An ARP table contains recently cached MAC addresses of every immediate device that was communicating with the router.

Active IPv4-Routes

Shows the routers routing table. The routing table indicates where a TCP/IP packet, with a specific IP address, should be directed to.

Realtime Graphs

Real-time graphs show how various statistical data changes over time.

Load

Realtime Load

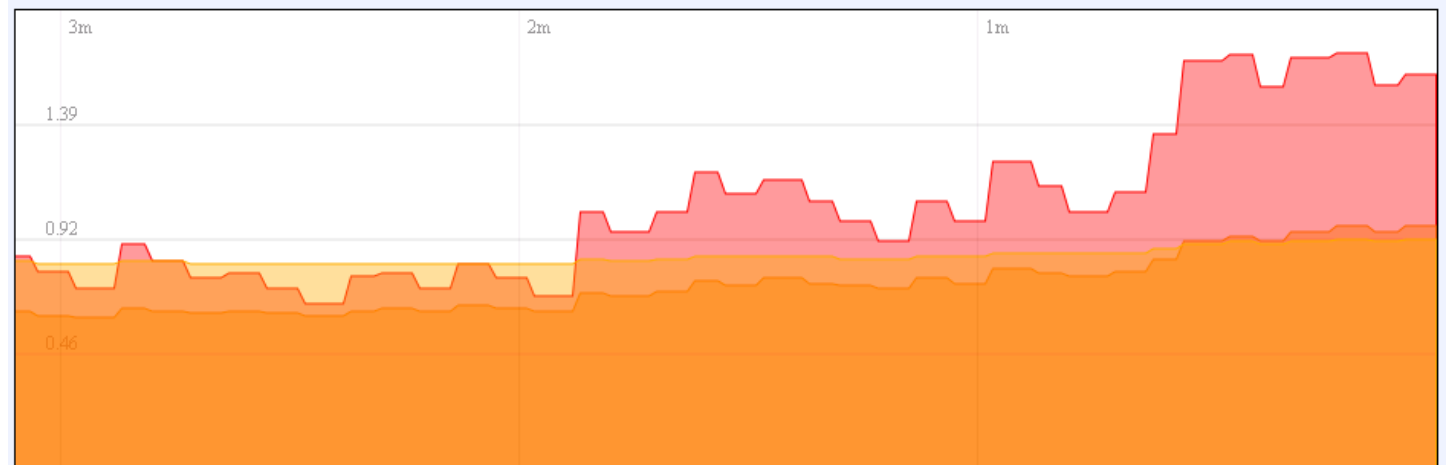

1 Minute Load: 1.59
5 Minute Load: 0.98
15 Minute Load: 1.59

Average: 1.59
Average: 0.98
Average: 0.93

Peak: 1.68
Peak: 0.98
Peak: 0.93

This tri-graph illustrates average system load over the course of ~3 minutes; each new measurement is taken every 3 seconds. The graph consists out of three colour coded graphs, each one corresponding to the average system load over 1 (red), 5 (orange) and 15 (yellow) most recent minutes. Although not graphed, the page also displays peak loads over 1, 5 and 15 minutes.

Traffic

Bridge

Realtime Traffic

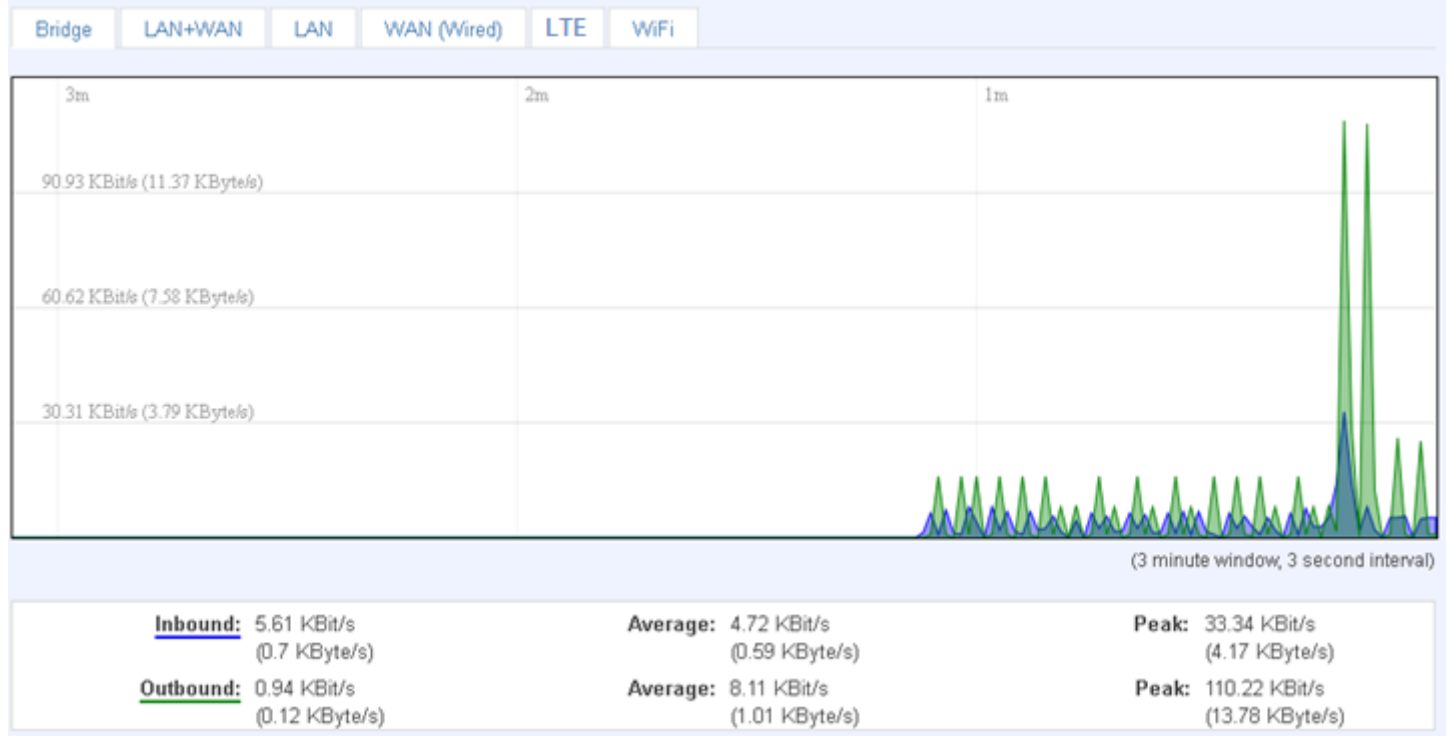

Cumulative graph, which encompasses wired Ethernet LAN and the wireless network.

LAN+WAN

Realtime Traffic

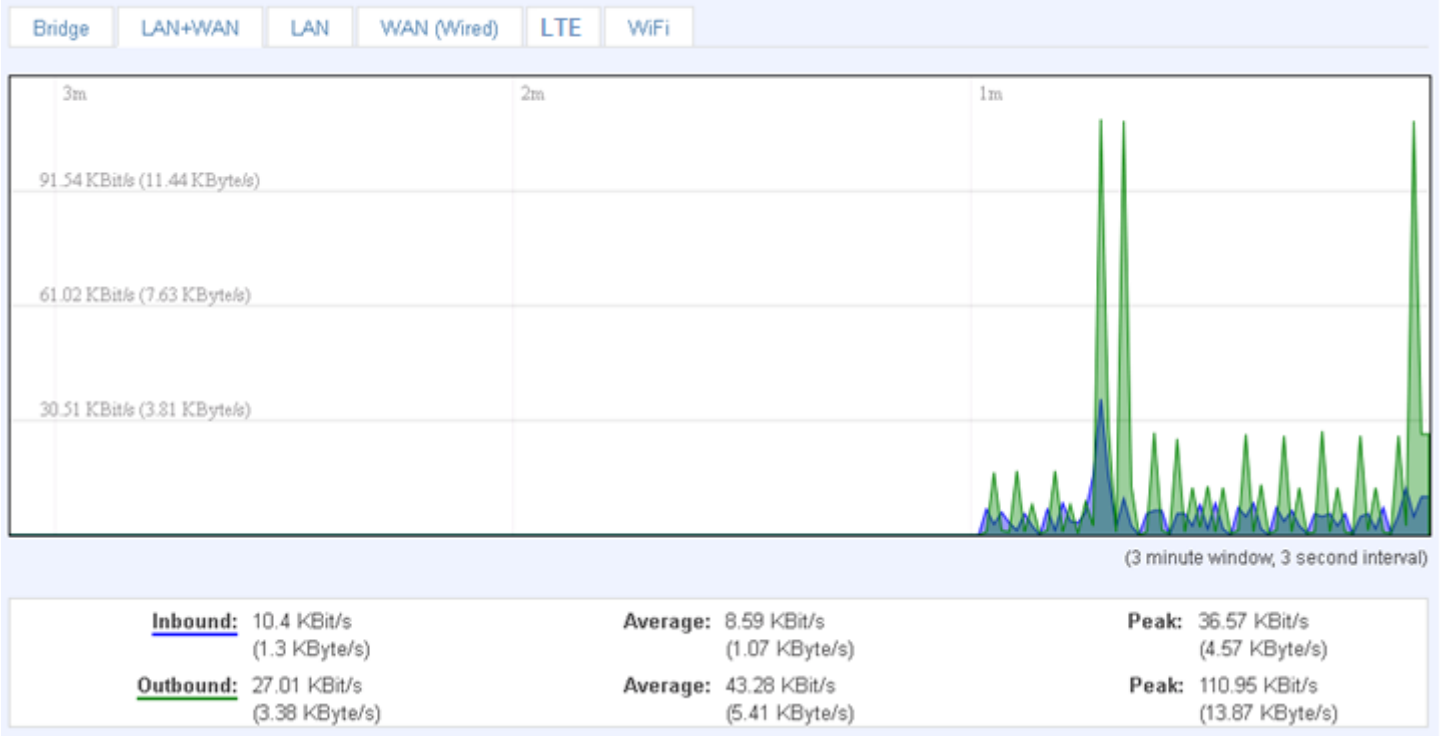

Graphs the total traffic that passes through both WAN and LAN network interfaces.

LAN

Realtime Traffic

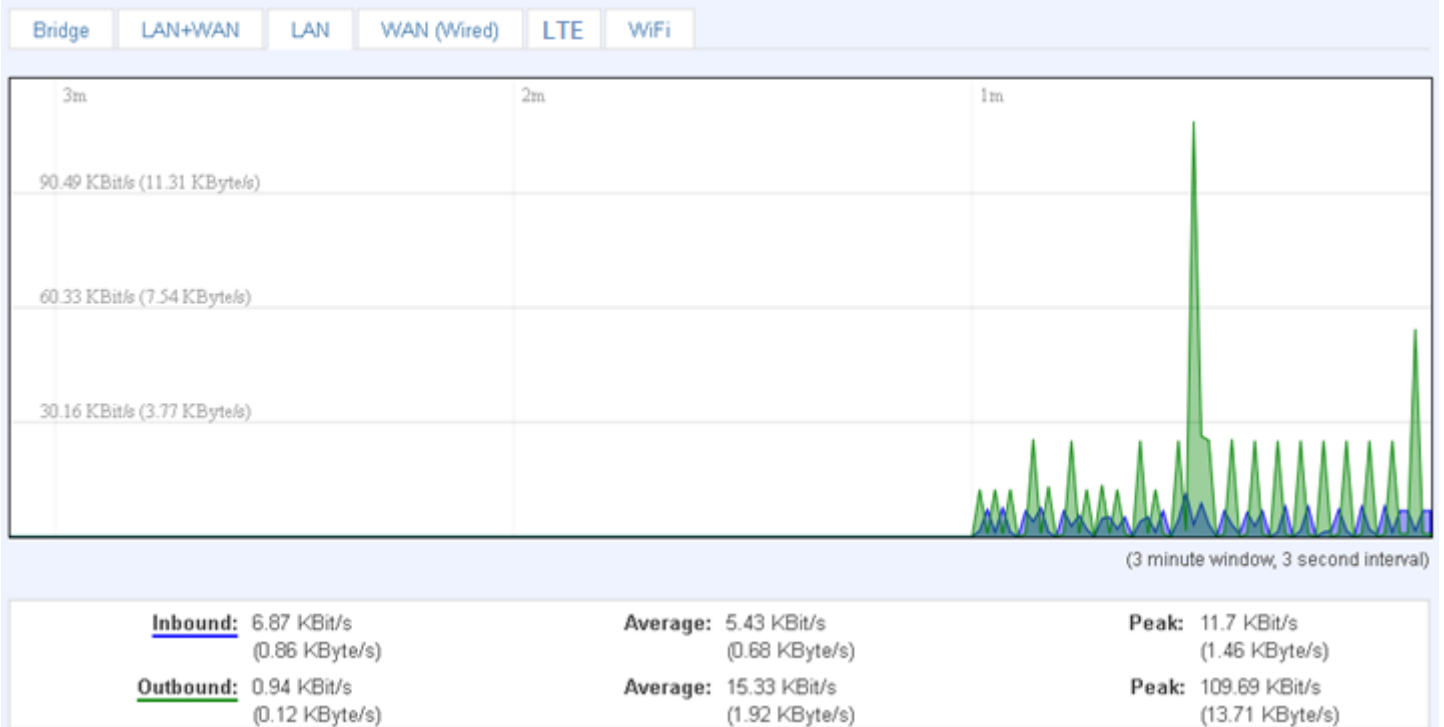

Indicates how much traffic has been passed through your Ethernet LAN network.

WAN(x)

Realtime Traffic

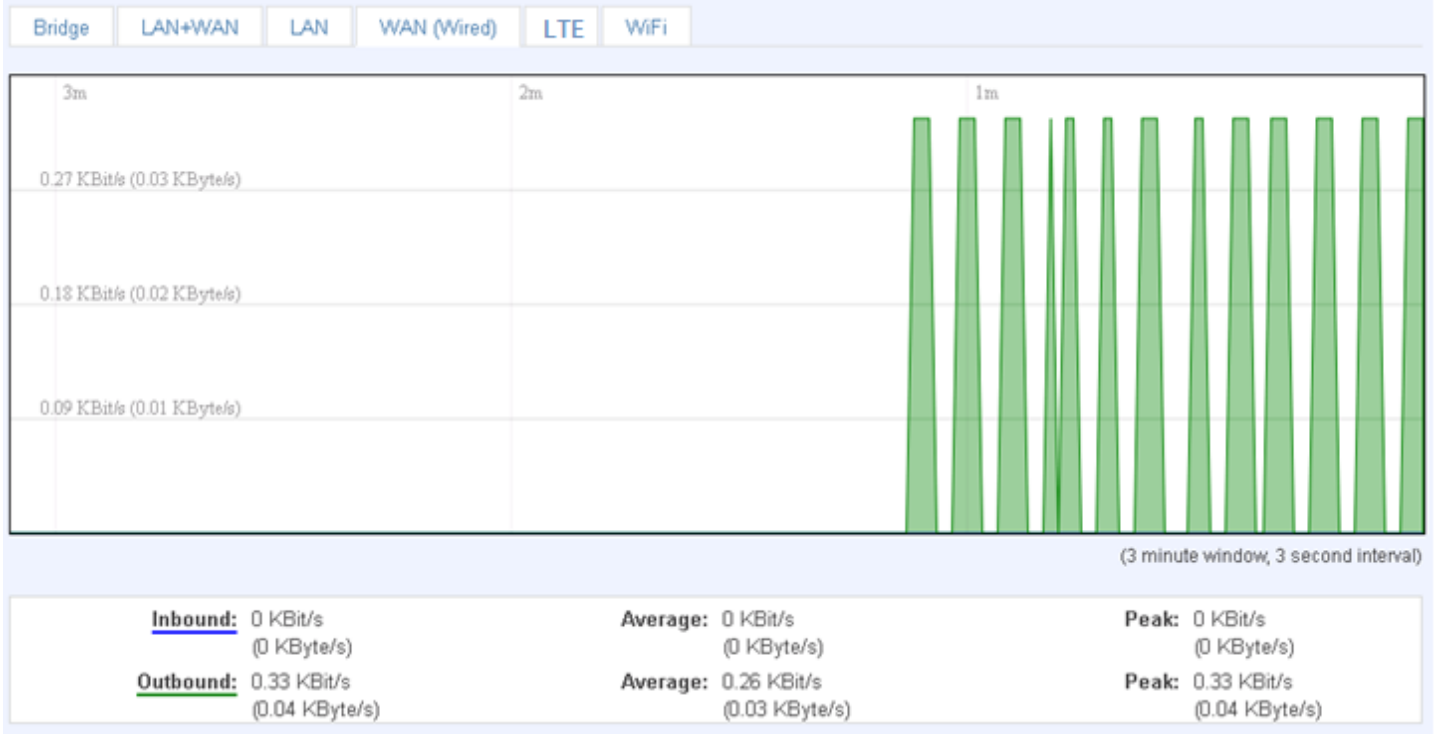

Graphs the amount of traffic which passed through the current active WAN connection.

Wi-Fi

Realtime Traffic



Shows the amount of traffic that has been sent and received through the wireless radio.

Wireless

Realtime Wireless

wlan0

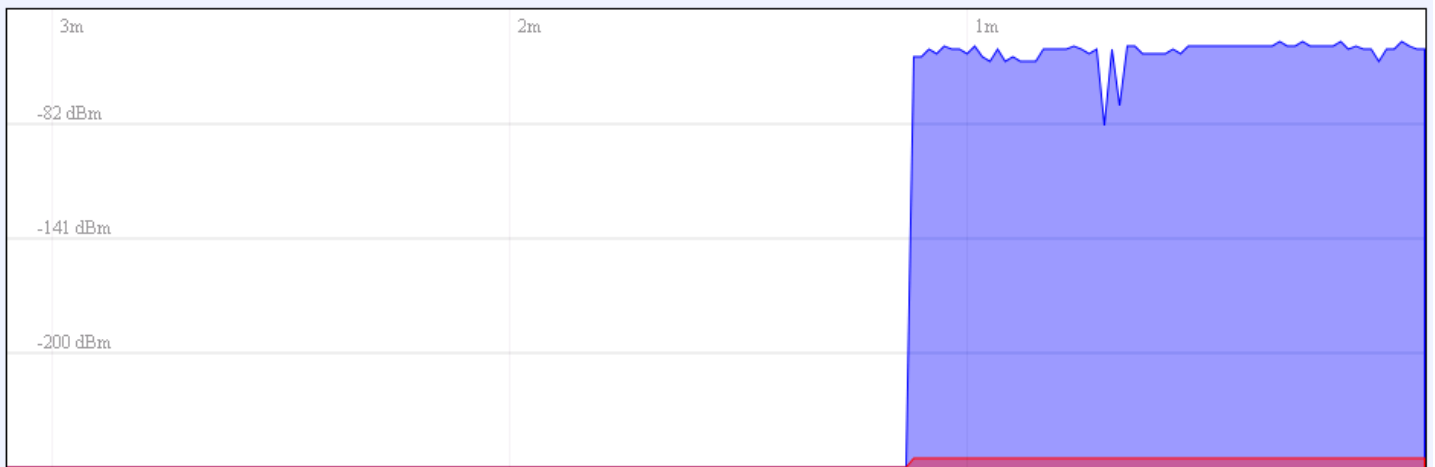

(3 minute window, 3 second interval)

Signal: -49 dBm (SNR 206 dBm)

Average: -48 dBm (SNR 206 dBm)

Peak: -45 dBm (SNR 210 dBm)

Noise: -255 dBm

Average: -255 dBm

Peak: -255 dBm

This graph illustrates how signal strength and the amount of noise change over time.

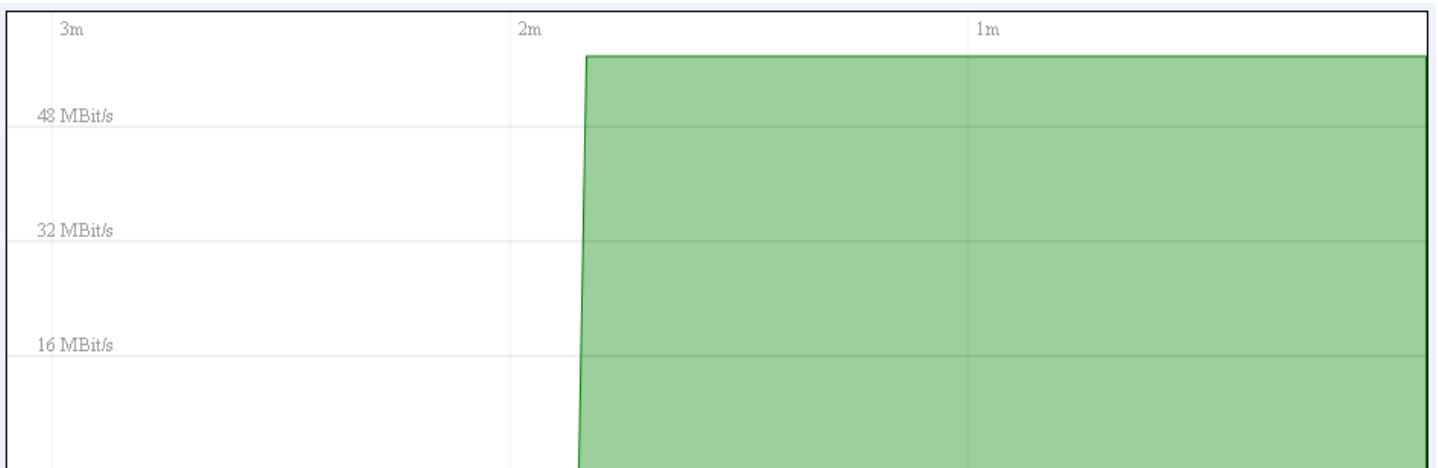

(3 minute window, 3 second interval)

Phy Rate: 59 MBit/s

Average: 59 MBit/s

Peak: 59 MBit/s

This graph illustrates how the physical rate of wireless changes over time.

Connections

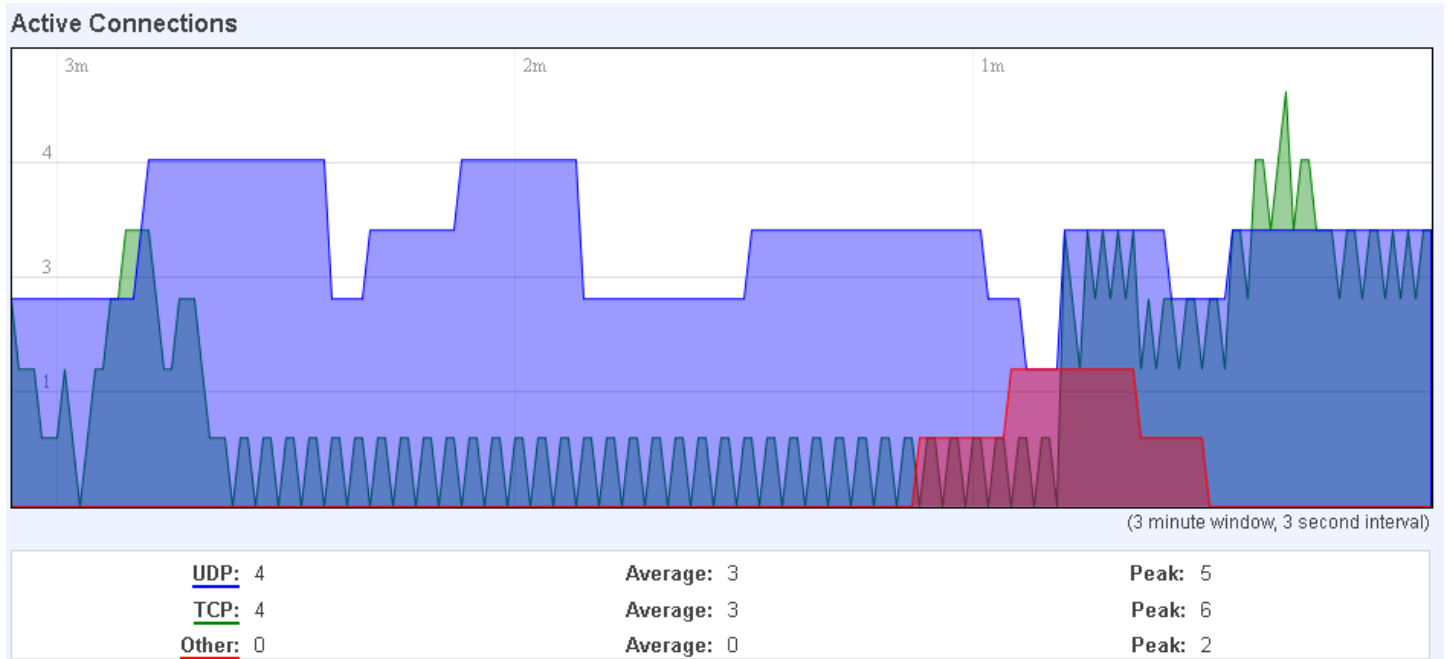

This graph shows a concise history of the amount of connections that the router maintained.

Blue graph indicates UDP connections, green TCP and red other types (ICMP, etc...). Other values indicate each respective graphs average and peak connection amounts over 3 minutes.

Network	Protocol	Source	Destination	Transfer
IPV4	TCP	192.168.0.156:37706	192.168.99.30:3389	613.24 KB (8338 Pkts.)
IPV4	UDP	192.168.0.19:137	192.168.0.255:137	7.24 KB (84 Pkts.)
IPV4	UDP	192.168.0.19:138	192.168.0.255:138	5.20 KB (24 Pkts.)
IPV4	TCP	192.168.0.156:52547	173.194.78.139:80	3.30 KB (11 Pkts.)
IPV4	TCP	192.168.0.156:38821	199.127.194.80:80	1.97 KB (17 Pkts.)
IPV4	UDP	192.168.1.9:67	255.255.255.255:68	1.13 KB (2 Pkts.)
IPV4	TCP	192.168.0.156:42797	209.85.148.148:80	930.00 B (5 Pkts.)
IPV4	TCP	192.168.0.30:55669	192.168.0.161:80	703.00 B (3 Pkts.)
IPV4	UDP	0.0.0.0:68	255.255.255.255:67	688.00 B (2 Pkts.)
IPV4	UDP	192.168.0.5:67	255.255.255.255:68	604.00 B (2 Pkts.)
IPV4	UDP	192.168.0.156:54245	8.8.8.8:53	142.00 B (2 Pkts.)
IPV4	UDP	192.168.0.156:41391	8.8.8.8:53	66.00 B (1 Pkts.)

On the same page you can also analyze a detailed list of all active connections that the router maintains. Each entry consist of a type of network ("IPV4"), protocol (TCP, UDP, ICMP), the source address (an IPv4 address + the source port), the destination address (an IPv4 address + the destination port) and how much traffic has gone through that particular connection: it's size in Bytes and the amount of packets.

Network

LTE

Here you can configure the LTE specific settings which are used when connecting to your local LTE network.

LTE Configuration

Here you can configure your LTE settings.

LTE Configuration

APN	<input type="text" value="bangapro"/>
PIN number	<input type="text" value="5555"/>
Authentication method	<input type="text" value="CHAP"/> ▼
Username	<input type="text" value="user"/>
Password	<input type="password" value="*****"/> 
Service mode	<input type="text" value="4G(LTE) preferred"/> ▼

Teltonika solutions: www.teltonika.lt

Alternate model:

LTE Configuration

Here you can configure your LTE settings.

LTE Configuration

APN	<input type="text"/>
PIN number	<input type="text"/>
Username	<input type="text"/>
Password	<input type="password"/> 
Service mode	<input type="text" value="automatic"/> ▼

Teltonika solutions: www.teltonika.lt

The configuration is simple and straightforward. Here we will gloss over all the fields:

	Field name	Possible values	Explanation
1.	APN	"bangapro"	Access Point Name (APN) is a configurable network identifier used by a mobile device when connecting to a GSM carrier.
2.	PIN Number	"5555" or any number that falls between 0000 and 9999	A personal identification number is a secret numeric password shared between a user and a system that can be used to authenticate the user to the system.
3.	Authentication method	CHAP, PAP or none	Authentication method, that your carrier uses to authenticate new connections. (This selection is unavailable on the alternate model)
4.	Username	"user"	Your username and password that you would use to connect to your carriers network. These field become available when you select an authentication method (i.e. authentication method is not "none"). These fields are always enabled on the alternate model.
5.	Password	"passwd"	
6.	Service mode	GSM, UMTS, LTE or automatic. Alternate model: 2G, 3G, LTE or none.	Your network preference. If your local mobile network supports both GSM (2G) and UMTS (3G) you can specify to which network you wish to connect. E.g.: if you choose GSM (2G), the router will connect to a GSM (2G) network, so long as it is available, otherwise it will connect to a UMTS (3G) network. If you select auto, then the router will connect to the network that provides better connectivity.

Warning: If an invalid PIN number was entered (i.e. the entered PIN does not match the one that was used to protect the SIM card), your SIM card will get blocked. To avoid such mishaps it is highly advised to use an unprotected SIM. If you happen to insert a protected SIM and the PIN number is incorrect, your card won't get blocked immediately, although after a couple of reboots OR configuration saves it will.

Wan

WAN configuration is, arguably, the crux of the routers configuration as it determines how the router will connect to the internet. Here is quick rundown of how the page looks and what each field means.

Operation Mode



First and foremost a mode of connection has to be defined. Available selections:

	Type	Description
1.	Wired	An Ethernet cable connected to the WAN port of the router.
2.	Wifi	The router will be able to connect to a local wireless access point and reach the internet through it.
3.	LTE	The router will connect to your local mobile network for LTE access.

Common configuration

Common configuration allows you to configure your TCP/IP settings for the wan network.

Common Configuration

General Setup

Protocol

Really switch
protocol?

You can switch between the Static, DHCP or PPPoE protocol by selecting the protocol that you want to use and then pressing **Switch Protocol**

General

This area is dedicated for protocol specific options.

Static:

The screenshot shows the 'Common Configuration' window with the 'General Setup' tab selected. The 'Protocol' dropdown is set to 'Static address'. The 'IPv4 address' field contains '192.168.99.162', 'IPv4 netmask' is '255.255.255.0', 'IPv4 gateway' is '192.168.99.254', and 'IPv4 broadcast' is empty. Under 'Use custom DNS servers', '8.8.8.8' is entered with a red 'x' icon, and '8.8.6.6' is entered with a green '+' icon.

This is the configuration setup for when you select the static protocol.

	Filed name	Sample	Explanation
1.	IPv4 address	192.168.99.162	Your routers address on the WAN network
2.	IPv4 netmask	255.255.255.0	A mask used to define how "large" the WAN network is
3.	IPv4 gateway	192.168.99.254	Address where the router will send all the outgoing traffic
4.	IPv4 broadcast	192.168.99.255	Broadcast address (autogenerated if not set). It is best to leave this blank unless you know what you are doing.
5.	custom DNS servers	8.8.8.8 8.8.6.6	Usually the gateway has some predefined DNS servers. As such the router, when it needs to resolve a hostname ("www.google.com", "www.cnn.com", etc...) to an IP address, it will forward all the DNS requests to the gateway. By entering custom DNS servers the router will take care of host name resolution. You can enter multiple DNS servers to provide redundancy in case the one of the server fails.

DHCP:

The screenshot shows the 'Common Configuration' window with the 'General Setup' tab selected. The 'Protocol' dropdown is set to 'DHCP client'. The 'Hostname to send when requesting DHCP' field contains 'Teltonika'.

When you select the DHCP protocol you can use it as is, because most networks will not require any additional advanced configuration.

PPPoE. This protocol is mainly used by DSL providers:

This is the configuration setup for when you select PPPoE protocol.

	Filed name	Sample	Explanation
1.	PAP/CHAP username	test	Your username and password that you would use to connect to your carriers network.
2.	PAP/CHAP password	your_password	
3.	Access Concentrator	isp	Specifies the name of access concentrator. Leave empty to autodetect.
4.	Service Name	isp	Specifies the name of the service. Leave empty to autodetect.

Advanced

These are the advanced settings for each of the protocols, if you are unsure of how to alter these attributes it is highly recommended to leave them to a trained professional:

Static:

	Field name	Sample value	Explanation
1.	Bring up on boot	On	Specifies whether the interface will be configured and brought up when the router boots up. Disabling will render your WAN connection non-functional
2.	Disable NAT	On/Off	Toggle NAT on and off.
3.	Override MAC address	00:0C:43:30:50:38	Override MAC address of the WAN interface. If your ISP gives you a static IP address it might also bind it to your computers MAC

			address (i.e. that IP will only work with your computer). In this field you can enter your computers MAC address and fool the gateway in thinking that it is communicating with your computer.
4.	Override MTU	1500	Maximum transmission unit – specifies the largest possible size of a data packet.
5.	Use gateway metric	0	The WAN configuration by default generates a routing table entry. With this field you can alter the metric of that entry.

DHCP:

Common Configuration

General Setup **Advanced Settings**

Bring up on boot

Disable NAT [?](#) If checked, router will not perform NAT (Masquerade) on this interface

Use broadcast flag [?](#) Required for certain ISPs, e.g. Charter with DOCSIS 3

Use default gateway [?](#) If unchecked, no default route is configured

Use DNS servers advertised by peer [?](#) If unchecked, the advertised DNS server addresses are ignored

Use gateway metric

Client ID to send when requesting DHCP

Vendor Class to send when requesting DHCP

Override MAC address

Override MTU

PPPoE:

Common configuration

General Setup **Advanced Settings**

Disable NAT [?](#) If checked, router will not perform NAT (Masquerade) on this interface

Use default gateway [?](#) If unchecked, no default route is configured

Use gateway metric

Use DNS servers advertised by peer [?](#) If unchecked, the advertised DNS server addresses are ignored

LCP echo failure threshold [?](#) Presume peer to be dead after given amount of LCP echo failures, use 0 to ignore failures

LCP echo interval [?](#) Send LCP echo requests at the given interval in seconds, only effective in conjunction with failure threshold

Inactivity timeout [?](#) Close inactive connection after the given amount of seconds, use 0 to persist connection

IP Aliases

IP aliases are a way of defining or reaching a subnet that works in the same space as the regular network.

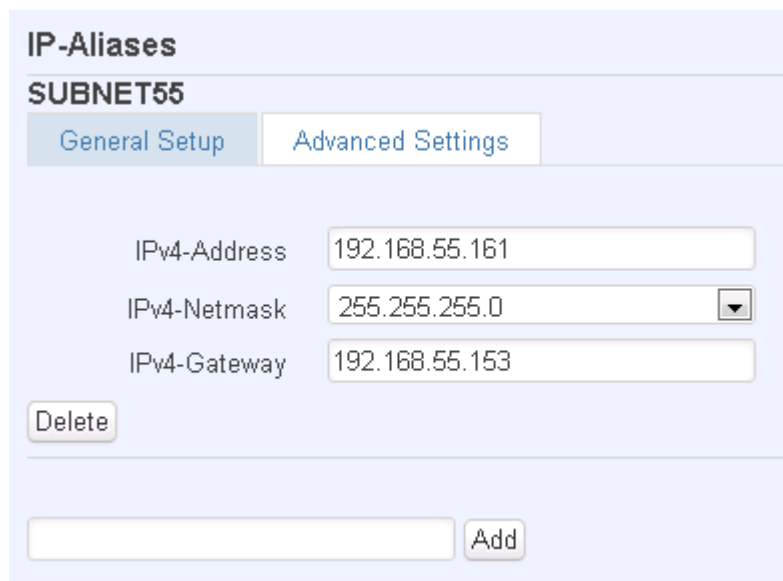

The screenshot shows the 'IP Aliases' configuration page for 'SUBNET55'. The 'General Setup' tab is selected. It contains three input fields: 'IPv4-Address' with the value '192.168.55.161', 'IPv4-Netmask' with the value '255.255.255.0' and a dropdown arrow, and 'IPv4-Gateway' with the value '192.168.55.153'. Below these fields is a 'Delete' button. At the bottom, there is an empty input field and an 'Add' button.

As you can see, the configuration is very similar to the static protocol; only in the example a 55'th subnet is defined. Now if some device has an IP in the 55 subnet (192.168.55.xxx) and the subnets gateway metric is "higher" and the device is trying to reach the internet it will reroute it's traffic not to the gateway that is defined in common configurations but through the one that is specified in IP aliases.

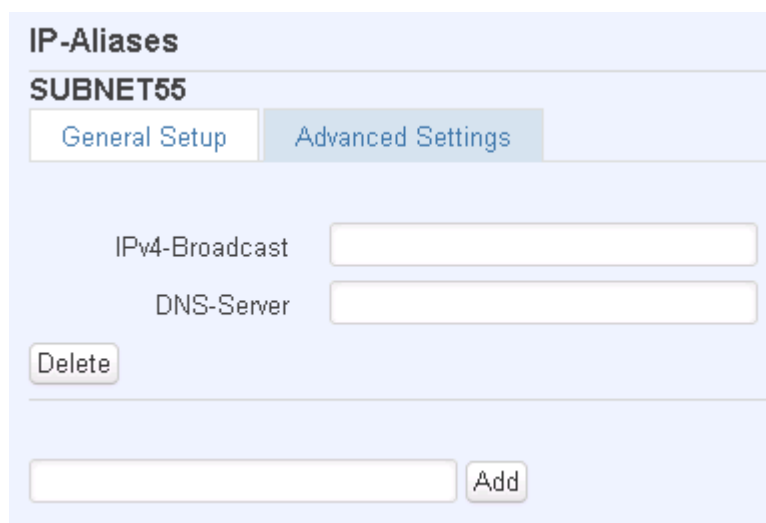

The screenshot shows the 'IP Aliases' configuration page for 'SUBNET55'. The 'Advanced Settings' tab is selected. It contains two input fields: 'IPv4-Broadcast' and 'DNS-Server'. Below these fields is a 'Delete' button. At the bottom, there is an empty input field and an 'Add' button.

You may also optionally define a broadcast address and a custom DNS server.

How do I setup Wifi WAN?

First we must switch the mode to Wifi. Do so by selecting Wifi from the list and wait for the page to quickly reload.

Now you have a selection of protocols available for you. Depending on whether the Access Point that you intend to connect to runs a DHCP server or not, you will have to choose DHCP or Static (AP runs a DHCP server – DHCP; Does not run - Static). When you've configured your protocol settings press Save and wait until the settings are applied.

Next, goto the Network -> Wireless page and wait until it loads (For the first time an automatic Site Survey will be initiated). You should now see a list of available, local Access Points. Choose one and click Join Network.

Should you be asked enter the secret Encryption Key and click Submit.

Now you should be transported to the Wireless Station page. Click Save and wait until all the settings are applied.

The configuration is complete and you should now be able to access the internet.

LAN

This page is used to configure the LAN network, where all your devices and computers that you connect to the router will reside.

LAN

On this page you can configure your LAN settings.

Common Configuration

General Setup Advanced Settings

Protocol	Static address	▼
IPv4 address	192.168.0.161	
IPv4 netmask	255.255.255.0	▼
IPv4 gateway		
IPv4 broadcast		
Use custom DNS servers	<input type="text"/> 	

IP-Aliases

This section contains no values yet

<input type="text"/>	Add
----------------------	-----

The common configuration and IP aliasing sections are identical to the ones found in WAN, so for an explanation on how they work please follow through there.

DHCP Server

The DHCP server is the router side service that can automatically configure the TCP/IP settings of any device that requests such a service. If you connect a device that has been configured to obtain IP address automatically the DHCP server will lease an address and the device will be able to fully communicate with the router.

DHCP Server

General Setup

Advanced Settings

Disable

Start

100

Limit

150

Leasetime

12h

Expiry time of leased addresses, minimum is 2 Minutes (2m).

	Field Name	Sample value	Explanation
1.	Disable	Checked/unchecked	Check to DISABLE the DHCP server.
2.	Start	100	The starting address of the range that the DHCP server can use to give out to devices. E.g.: if your LAN IP is 192.168.2.1 and your subnet mask is 255.255.255.0 that means that in your network a valid IP address has to be in the range of [192.168.2.1 – 192.168.2.254](192.168.2.0 and 192.168.2.255 are special unavailable addresses). If the Start value is set to 100 then the DHCP server will only be able to lease out addresses starting from 192.168.2.100
3.	Limit	150	How many addresses the DHCP server gets to lease out. Continuing on the above example: if the start address is 192.168.2.100 then the end address will be 192.168.2.254 (100 + 150 – 1 = 254).
4.	Lease time	12h	How long can a leased IP be considered valid. An IP address after the specified amount of time will expire and the device that leased it out will have to request for a new one.

Advanced settings

You can also define some advanced options that specify how the DHCP server will operate on your LAN network.

DHCP Server

General Setup

Advanced Settings

Dynamic DHCP

Force

Force DHCP on this network even if another server is detected.

IPv4 netmask

DHCP-Options

Define additional DHCP options, for example "6,192.168.2.1,192.168.2.2" which advertises different DNS servers to clients.

	Field Name	Sample Value	Explanation
1.	Dynamic DHCP	Checked/Unchecked	Dynamically allocate client addresses, if set to 0 only clients present in the <code>ethers</code> files are served
2.	Force	Checked/Unchecked	Forces DHCP serving even if another DHCP server is detected on the same network segment.
3.	IPv4 netmask	255.255.255.0	You can override your LAN netmask here to make the DHCP server think it's serving a larger or a smaller network than it actually is.

4.	DHCP-Options	6,192.168.2.1,192.168.2.2 26,1470 option:mtu, 1470	Additional options to be added for this DHCP server. For example with '26,1470' or 'option:mtu, 1470' you can assign an MTU per DHCP. Your client must accept MTU by DHCP for this to work.
----	--------------	--	---

Wireless

On this page you can configure your wireless settings. Depending on whether your WAN mode is set to Wifi or not, the page will display either the options for configuring an **Access Point** or options for configuring a **connection** to some local access point.

Access Point:

Wireless Access Point

Here you can configure your wireless settings like radio frequency, mode, encryption etc...

Device Configuration

General Setup

Advanced Settings

Wireless network is Disable
enabled Don't forget to save before toggling the wireless radio on and off.

Channel 11 (2.462 GHz)

Interface Configuration

General Setup

Wireless Security

MAC-Filter

ESSID Teltonika

Hide ESSID

Save

Here you can see the Overview of the wireless configuration. It is divided into two main sections – device and interface. One is dedicated to configuring hardware parameters other – software.

Device

General

Device Configuration

General Setup

Advanced Settings

Wireless network is Disable
enabled Don't forget to save before toggling the wireless radio on and off.

Channel 11 (2.462 GHz)

Here you can toggle the availability of the wireless radio and the physical channel frequency.

Important note: As seen in the picture you should always **Save** before toggling the radio on and off.

Advanced

Device Configuration

General Setup
Advanced Settings

Mode

HT mode

Country Code

Use ISO/IEC 3166 alpha2 country codes.

Distance Optimization

Distance to farthest network member in meters.

Fragmentation Threshold

RTS/CTS Threshold

Here you can configure more advanced parameters:

	Field name	Sample value	Explanation
1.	Mode	Auto, b, g, g+n	Different modes provide different throughput and security options.
2.	Country Code	Any ISO/IEC 3166 alpha2 country code	Selecting this will help the wireless radio configure its internal parameters to meet your countries wireless regulations.
3.	Distance Optimization	100	Distance to farthest network member in meters.
4.	Frag. Threshold	2346	The smallest packet size that can be fragmented and transmitted by multiple frames. In areas where interference is a problem, setting a lower fragment threshold might help reduce the probability of unsuccessful packet transfers, thus increasing speed.
5.	RTS/CTS Threshold	2346	Request to send threshold. It can help resolve problems arising when several access points are in the same area, contending.

Interface

General

Interface Configuration

General Setup
Wireless Security
MAC-Filter

ESSID

Hide ESSID

ESSID – Your wireless networks identification string. This is the name of your Wi-Fi network. When other Wi-Fi capable computers or devices scan the area for Wi-Fi networks they will see your network with this name.

Hide ESSID – Will render your SSID hidden from other devices that try to scan the area.

Security

Interface Configuration

General Setup | **Wireless Security** | MAC-Filter

Encryption: WPA2-PSK

Cipher: auto

Key: ●●●●●●●●

Encryption – There are many modes of encryption, though two distinctive classes have to be pointed out.

WEP

Encryption: WEP Open System

Used Key Slot: Key #1

Key #1: []

Key #2: []

Key #3: []

Key #4: []

Enter the keys that will be used as passphrase for connecting computers and then specify which key will be preferred above the remaining. It's sufficient to enter one key and then specify it as the preferred one. Length is important as well: 10 or 26 characters in length in hex mode OR 5 or 13 in ASCII mode. A hex key may only contain numbers '0' through '9' and letters 'a' through 'f'.

WPA

Encryption: WPA-PSK

Cipher: auto

Key: ●●●●●●●●

First select an encryption method: TKIP, CCMP, TKIP&CCMP, auto. Note: Some authentication methods won't support TKIP (and TKIP&CCMP) encryption. After you've selected your encryption method, you should enter your passphrase, which must be at least 8 characters long.

MAC-Filter

Interface Configuration

General Setup | Wireless Security | **MAC-Filter**

MAC-Address Filter: Allow listed only

MAC-List:

Filter – you can define a rule for what to do with the MAC list you've defined. You can either allow only the listed MACs or allow ALL, but forbid only the listed ones.

Client

Client mode is nearly identical to AP, except for the fact that most of the options are dictated by the wireless access point that the router is connecting to. Changing them can result in an interrupted connection to an AP.

In addition to standard options you can also click the **Scan** button to rescan the surrounding area and attempt to connect to a new wireless access point.

Backup WAN

Backup WAN is a function that allows you to back up your wired OR wireless connection in case they go down. At the current moment you can only backup wired/Wifi with LTE.

Backup Link

Here you can setup your backup link. If your conventional WAN connection, such as wired Ethernet or Wifi, fails, the backup link will enable and take over to keep the router connected.

Enable

Timing & other parameters

Timing & other parameters will indicate how and when it will be determined that your conventional connection has gone down.

Health Monitor Interval: 5 sec.

Health Monitor ICMP Host(s): DNS Server(s)

Health Monitor ICMP Timeout: 1 sec.

Attempts Before WAN Failover: 1

Attempts Before WAN Recovery: 1

DNS Server(s): Auto

Backup ICMP host

A remote host that will be used to test whether your backup link is alive.

ICMP host: 8.8.4.4

Save

The majority of the options consist of timing and other important parameters that help determine the health of your primary connection. Regular health checks are constantly performed in the form of ICMP packets (PINGs) on the your primary connection. When the connections state starts to change (READY->NOT READY and vice versa) a necessary

amount of failed or passed health checks has to be reached before the state changes completely. This delay is instituted so as to mitigate “spikes” in connection availability, but it also extends the time before the backup link can be brought up or down.

	Field Name	Sample value	
1.	Health Monitor Interval	Dsb/5/10/20/30/60/120 Seconds	The interval at which health checks are performed
2.	Health Monitor ICMP HOST	Dsb/DNS/WAN GW/Custom	Where to PING for a health check. As there is no definitive way to determine when the connection to internet is down for good, you’ll have to define a host whose availability that of the internet as a whole.
3.	Health Monitor ICMP Timeout	½/3/4/5/10 Seconds	How long to wait for an ICMP request to come back. Set a higher value if your connection has high latency or high jitter (latency spikes).
4.	Attempts Before WAN Failover	1/3/5/10/15/20	How many checks should fail for your WAN connection to be declared DOWN for good.
5.	Attempts Before WAN Recovery	1/3/5/10/15/20	How many checks should pass for your WAN connection to be declared UP.
6.	DNS Servers	Auto/Custom	Define custom DNS servers. Has meaning when you select DNS as your Health Monitor ICMP HOST.
7.	Backup ICMP host	IPv4 address	This is where the address of an ICMP host, that will be used to check the health of your LTE backup link, goes. This has to be a ping-able host.

How do I set up a backup link?

First we must pick a main link: Wired or Wi-Fi, and ensure that the link is working. Configure your WAN settings to use that link and see whether you have internet access. If the main link is working we can continue configuring our Backup Link.

Now, go to Backup WAN page and configure the settings to your liking. Click Save and wait until the settings are applied.

Now in the Status -> Network Information page there should be a status indication for the backup WAN. If everything is working correctly you should see this:

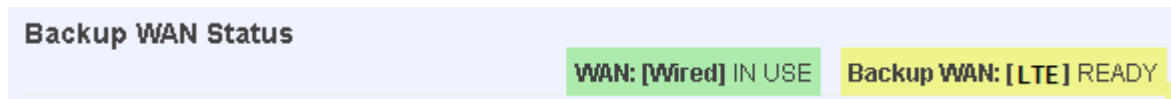

The above picture shows the status for Backup WAN configured on a wired main link. You can now simulate a downed link by simply unplugging your Ethernet WAN cable. When you’ve done so you should see this:



And, if you plug the cable back in you should, again, see this:

Backup WAN Status

WAN: [Wired] IN USE

Backup WAN: [LTE] READY

If you witness the above sequence, your backup link is working!

Firewall

In this section we will look over the various firewall features that come with RUT550.

General Settings

The routers firewall is a standard linux iptables package, which uses routing chains and policies to facilitate control over inbound and outbound traffic.

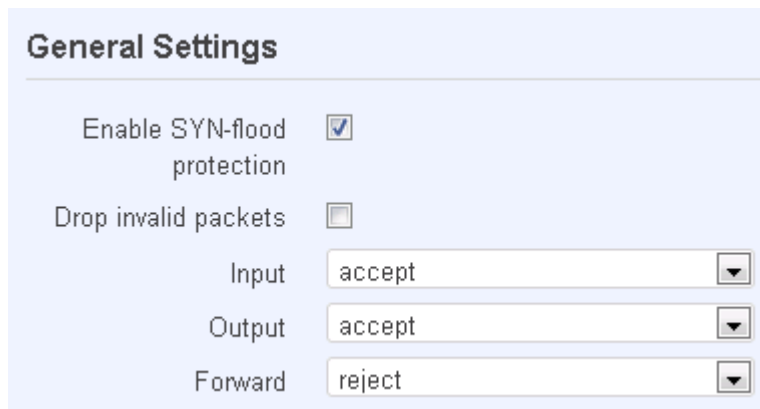

General Settings

Enable SYN-flood protection

Drop invalid packets

Input

Output

Forward

	Field name	Sample value	Explanation
1.	Enable SYN-flood protection	Checked/Unchecked	When checked the router becomes more resistant against SYN-flood attacks.
2.	Drop Invalid packets	Checked/Unchecked	A "Drop" action is performed on a packet that is determined to be invalid
3.	Input	Reject/Drop/Accept	DEFAULT* action that is to be performed for packets that pass through the Input chain.
4.	Output	Reject/Drop/Accept	DEFAULT* action that is to be performed for packets that pass through the Output chain.
5.	Forward	Reject/Drop/Accept	DEFAULT* action that is to be performed for packets that pass through the Forward chain.

*DEFAULT: When a packet goes through a firewall chain it is matched against all the rules for that specific chain. If no rule matches said packet, an according Action (either Drop or Reject or Accept) is performed.

Accept – Packet gets to continue down the next chain.

Drop – Packet is stopped and deleted.

Reject – Packet is stopped, deleted and, differently from Drop, an ICMP packet containing a message of rejection is sent to the **source** of the dropped packet.

DMZ

DMZ configuration
Enabled
DMZ host IP address

By enabling DMZ for a specific internal host (for e.g.: your computer), you will expose that host and its services to the routers WAN network (i.e. - internet).

Port Forwarding

Here you can define your own port forwarding rules.

Firewall - Port Forwarding
Port forwarding allows remote computers on the Internet to connect to a specific computer or service within the private LAN.

Port Forwarding

Name	Protocol	Source	Via	Destination	Enable	Sort
localWebsite	TCP	From <i>any host</i> in wan	To <i>any router IP</i> at port 12345	Forward to IP 192.168.99.156, port 80 in lan	<input checked="" type="checkbox"/>	Edit Delete

New port forward:

Name	Protocol	External port	Internal IP address	Internal port	
localWebsite	TCP+UDP	12345	192.168.99.156	80	Add

Save

You can use port forwarding to set up servers and services on local LAN machines. The above picture shows how you can set up a rule that would allow a website that is being hosted on 192.168.99.156, to be reached from the outside by entering `http://routersExternalIp:12345/`.

	Field Name	Sample Value	Explanation
1.	Name	"localWebsite"	Name of the rule. Used purely to make it easier to manage rules.
2.	Protocol	TCP/UDP/TCP+UDP/Other	Type of protocol of incoming packet.
3.	External Port	1- 65535	From what port on the WAN network will the traffic be forwarded.
4.	Internal IP address	IPv4 address of some computer on your LAN	The IP address of the internal machine that hosts some service that we want to access from the outside.
5.	Internal port	1-65535	To what port on the internal machine would the rule redirect the traffic.

Additional note: Notice how the external port is 12345 and not 80. It is perfectly fine to define the external port as 80, but then the routers configuration interface would not be reachable (unless you change the web access port from remote management).

When you click **edit** you can fine tune a rule to near perfection, if you should desire that.

Traffic Rules

The traffic rule page contains a more generalised rule definition. With it you can block or open ports, alter how traffic is forwarded between LAN and WAN and many more things.

	Field name	Sample Value	Explanation
1.	Name	"ruleName"	Used to make rule management easier
2.	Family	IPv4	Only IPv4 is currently supported
3.	Protocol	TCP/UDP/Other...	Protocol of the packet that is being matched against traffic rules.
4.	Source	IPv4 address	The source of the packet.
5.	Destination	IPv4 address	The destination of the packet
6.	Action	Drop/Accept/Reject + chain + additional rules	Action to be taken on the packet if it matches the rule. You can also define additional options like limiting packet volume, and defining to which chain the rule belongs
7.	Enable	Checked/Unchecked	Self-explanatory. Uncheck to make the rule inactive. The rule will not be deleted, but it also will not be loaded into the firewall.
8.	Sort	Up/Down	When a packet arrives, it gets checked for a matching rule. If there are several rules that match the rule, the first one is applied i.e. the order of the rule list impacts how your firewall operates, therefore you are given the ability to sort your list as you wish.

Custom Rules

Here you have the ultimate freedom in defining your rules – you can enter them straight into the iptables program. Just type them out into the text field and it will get executed as a linux shell script. If you are unsure of how to use iptables, check the internet out for manuals, examples and explanations.

Static Routes

Static routes provide a way of entering custom entries in the internal routing table of the router.

Routes

Routes specify over which interface and gateway a certain host or network can be reached.

Static IPv4 Routes

Interface	Target	IPv4-Netmask	IPv4-Gateway	Metric	
	Host-IP or Network	if target is a network			
lan	192.168.55.0	255.255.255.0	192.168.55.145	0	Delete

Add Save

	Field name	Value	Explanation
1.	Interface	Lan/wan	The zone where the 'Target' resides
2.	Target	IPv4 address	The source of the traffic.
3.	IPv4-Netmask	IPv4 mask	Mask that is applied to the Target to determine to what actual IP addresses the routing rule applies
4.	IPv4-Gateway	IPv4 address	To where the router should send all the traffic that applies to the rule
5.	Metric	integer	Used as a sorting measure. If a packet about to be routed fits two rules, the one with the higher metric is applied.

Additional note on Target & Netmask: You can define a rule that applies to a single IP like this: Target - some IP; Netmask - 255.255.255.255. Furthermore you can define a rule that applies to a segment of IPs like this: Target – some IP that STARTS the segment; Netmask – Netmask that defines how large the segment is. E.g.:

192.168.55.161	255.255.255.255	Only applies to 192.168.55.161
192.168.55.0	255.255.255.0	Applies to IPs in range 192.168.55.0-192.168.55.255

192.168.55.240	255.255.255.240	Applies 192.168.55.240 - 192.168.55.255
192.168.55.161	255.255.255.0	192.168.55.0 - 192.168.55.255
192.168.0.0	255.255.0.0	192.168.0.0 - 192.168.255.255

Diagnostics

Contains Network Utilities used for testing network.

Network Utilities

Ping – the utility used to test the reachability of a host on an Internet IP network and to measure the round-trip time for messages sent from the originating host to a destination server. Enter server IP address or hostname and click “Ping”. Server echo response will be shown after few seconds if server is accessible.

Traceroute – diagnostic tool for displaying the route (path) and measuring transit delays of packets across an Internet IP network. Enter server IP address or hostname and click “Traceroute”. Log containing route information will be shown after few seconds.

Nslookup – network administration command-line tool for querying the Domain Name System (DNS) to obtain domain name or IP address mapping or for any other specific DNS record. Enter server hostname and click “Nslookup”. Log containing specified server DNS lookup information will be shown after few seconds. Full manual with all available “Nslookup” commands and parameters can be found in Linux manual page nslookup(1).

Important notes:

- Note that DNS server must be configured correctly if you use server hostname instead of server IP address in address field.

Services

PING Reboot

PING Reboot function will periodically send PING command to server and waits for echo receive. If no echo is received router will try again sending PING command defined number times, after defined time interval. If no echo is received after the defined number of unsuccessful retries, router will reboot. It is possible to turn of the router rebooting after defined unsuccessful retries. Therefore this feature can be used as “Keep Alive” function, when router PINGs the host unlimited number of times.

Common configuration

Enable PING Reboot
 Reboot router if no echo received
 Interval between PINGs (min) Minimum 5 minutes
 Retry count
 Server to PING
e.g. 192.168.1.1 (or www.host.com if DNS server configured correctly)

	Field name	Description	Notes
1.	Enable PING Reboot	This check box will enable or disable PING reboot feature.	PING Reboot is disabled by default.
2.	Reboot router if no echo received	This check box will disable router rebooting after the defined number of unsuccessful retries.	This check box must be unselected if you want to use PING Reboot feature as “Keep Alive” function.
3.	Interval between PINGs	Time interval in minutes between two PINGs.	Minimum time interval is 5 minutes.
4.	Retry count	Number of times try sending PING to server after time interval if echo receive was unsuccessful.	Minimum retry number is 1. Second retry will be done after defined time interval.
5.	Server to PING	Server IP address or host name, which will receive PING from router	If you use server host name instead of the IP address you must configure DNS server first.

Important notes:

- Always check if your defined server responds to echo commands before using PING Reboot function. Otherwise router keeps rebooting after unsuccessful PING echo receive. You can test PING send at “Network” > “Diagnostics”.

SMS Reboot

It is possible to reboot router via SMS text message. This function is useful when router does not respond and it is difficult to manually restart router by hand.

Common configuration

Enable SMS Reboot
 SMS text
 Sender phone number e.g. +37012345678
 Get status Get detailed router connection information via SMS message after SMS reboot

	Field name	Description	Notes
1.	Enable SMS Reboot	This check box will enable and disable SMS reboot function.	SMS reboot is disabled by default.
2.	SMS text	SMS text which will reboot router.	SMS text can contain letters, numbers, spaces and special symbols. Capital letters also matters.
3.	Sender phone number	Phone number of person who can reboot router via SMS message	You can add as many phone numbers as you need. Dropdown list with additional rows will show up if you click on “add” icon at the end of phone number row.
4.	Get status	Check this to receive connection status via SMS after a reboot.	Disabled by default.

Status via SMS

It is possible to get routers connection status via SMS text message.

Common configuration

Enable SMS Status

SMS text

Sender phone number  e.g. +37012345678

	Field name	Description	Notes
1.	Enable SMS Status	This check box will enable and disable SMS status function.	SMS status is disabled by default.
2.	SMS text	SMS text which will send routers status.	SMS text can contain letters, numbers, spaces and special symbols. Capital letters also matters.
3.	Sender phone number	Phone number of person who can receive router status via SMS message	You can add as many phone numbers as you need. Dropdown list with additional rows will show up if you click on “add” icon at the end of phone number row.

Important Notes:

- LTE settings must be configured correctly. If SIM card has PIN number you must enter it at “Network” > “LTE” settings. Otherwise SMS reboot function will not work.
- Sender phone number must contain country code. You can check sender phone number format by reading the details of old SMS text messages you receiving usually.

NTP

Hostname, Network Time Protocol (NTP) and time zone configuration settings is needed to periodically update router local time.

Common configuration

System Properties

Local Time Wed Aug 8 08:32:11 2012

Hostname

Timezone

Time Synchronization

Enable builtin NTP

NTP server candidates

“Sync with browser” button will synchronize local router time with computer browser time.

	Field name	Description	Notes
1.	Local Time	Local time of router.	---
2.	Hostname	Hostname of router.	---
3.	Timezone	Time zone of your country.	---
4.	Enable builtin NTP	This check box will turn on automatic time synchronizing with defined NTP servers.	When check box is selected you must enter one or more working NTP servers. Otherwise time sync feature will not work.
5.	NTP server candidates	NTP server hostname.	You can add as many servers as you need by clicking “add” button at the end of server hostname field.

Dynamic DNS

Dynamic DNS (DDNS) is a domain name service allowing to link dynamic IP addresses to static hostname.

To start using this feature firstly you should register to DDNS service provider.

You are provided with add/delete buttons to manage and use different DDNS configurations at the same time!

Dynamic DNS

Dynamic DNS allows that your router can be reached with a fixed hostname while having a dynamically changing IP address.

DEMO

Enable

Status N/A

Service

Hostname

Username

Password 

IP renew interval (min)

Force IP renew (min)

	Field name	Description
1.	Enable	Enables current DDNS configuration.
2.	Status	Timestamp of the last IP check or update.
3.	Service	Your dynamic DNS service provider selected from the list: 1. dydns.org 2. 3322.org 3. no-ip.com 4. easydns.com 5. zoneedit.com In case your DDNS provider is not present from the ones provided, please feel free to use "custom" and add hostname of the update URL.
4.	Hostname	Domain name which will be linked with dynamic IP address.
5.	Username	Name of the user account.
6.	Password	Password of the user account.
7.	IP renew interval	Time interval (in minutes) to check if the IP address of the device have changed.
8.	Force IP renew	Time interval (in minutes) to force IP address renew.

Wireless hotspot

Wireless hotspot provides essential functionality for managing an open access wireless network. In addition to standard RADIUS server authentication there is also the ability to gather and upload detailed logs on what each device (denoted as a MAC address) was doing on the network (what sites were traversed and so on...).

General Settings

General Settings

Enabled

AP IP
? The IP address of the router on the hotspot network.

Radius server #1

Radius server #2

Authentication port

Accounting port

Hotspot name

Secret key 

Allowed hosts 





Picture above illustrate a sample configuration of the general section.

	Field name	Explanation
1.	Enabled	Check this flag to enable hotspot functionality on the router.
2.	AP IP	Access Point IP address. This will be the address of the router on the hotspot network. The router will automatically create a network according to its own IP and the CIDR number that you specify after the slash. E.g. "192.168.182.254/24" means that the router will create a network with the IP address 192.168.182.0, netmask 255.255.255.0 for the express purpose of containing all the wireless clients. Such a network will be able to have 253 clients (their IP addresses will be automatically granted to them and will range from 192.168.182.1 to 192.168.182.253).
3.	Radius server #1	The IP address of the RADIUS server that is to be used for Authenticating your wireless clients.
4.	Radius server #2	The IP address of the second RADIUS server.
5.	Authentication port	RADIUS server authentication port.
6.	Accounting port	RADIUS server accounting port.
7.	Hotspot name	The name of your hotspot. Will appear on the login screen.
8.	Secret Key	The secret key used for authenticating with the RADIUS server.
9.	Allowed hosts	A list of hosts that your clients will be able to reach regardless of whether they were authenticated or not.

Logging and FTP settings

Logging Settings

Enabled

Upload via FTP Settings

Enabled

Server address

Username

Password

Port

Intervals

You configure upload timing settings here.

Description

Mode

Weekdays

Enter numbers corresponding weekdays separated by commas. E.g. Monday, Tuesday and Friday would be 1,2,5

Upload interval

The above picture illustrates a sample configuration of the Logging and FTP settings portion of the page.

	Field name	Explanation
1.	Logging enabled	Check this box if you want to enable wireless traffic logging. This feature will produce logs which contain data on what websites each client was visiting during the time he was connected to your hotspot.
2.	FTP enabled	Check this box if you want you logs to be periodically uploaded to an FTP server of your choice.
3.	Server address	The IP address of the FTP server to which you want the logs uploaded.
4.	Username	The username of the user on the aforementioned FTP server.
5.	Password	The password of the user.
6.	Port	The TCP/IP Port of the FTP server.
7.	Description	The description of the schedule.
8.	Mode	The mode of the schedule. Use "Fixed" if you want the uploading to be done on a specific time of the day. Use "Interval" If you want the uploading to be done at fixed interval.
9.	Weekdays	This field specifies on what weekdays the uploading should be done. The entry format is numbers from 1 to 7 separated by only commas. E.g. If you want to upload the logs on Monday, Wednesday and Saturday you should enter "1,3,6".
10.	Interval	Shows up only when "Mode" is set to Interval. Specifies the interval of regular uploads on one specific day. E.g. If you choose 4 hours, the uploading will be done on midnight, 4:00, 8:00, 12:00, 16:00 and 20:00.
11.	Hours, Minutes	Shows up only when "Mode" is set to Fixed. Uploading will be done on that specific time of the day. E.g. If you want to upload your logs on 6:48 you will have to simply enter hours: 6 and minutes: 48.

You can also one than more uploading schedule. Simply click Add at the very bottom of the configuration page and an additional configuration box will appear.

OpenVPN

VPN (Virtual Private Network) is a method for secure data transfer through unsafe public network. This section explains how to configure OpenVPN, which is implementation of VPN supported by the RUT550 router.

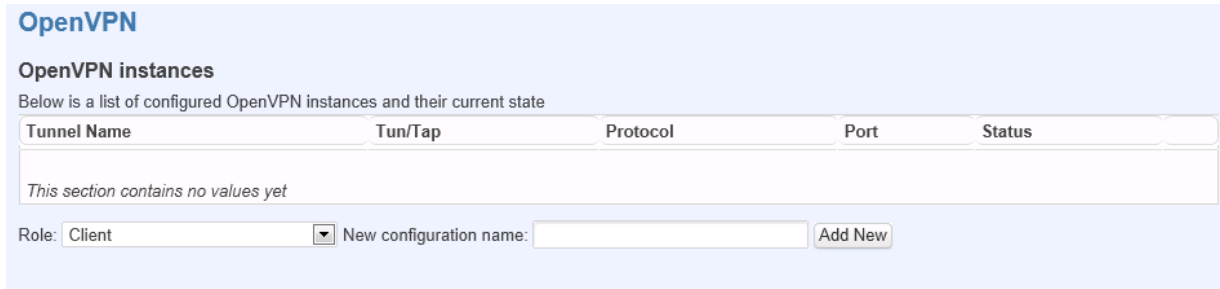

OpenVPN

OpenVPN instances

Below is a list of configured OpenVPN instances and their current state

Tunnel Name	Tun/Tap	Protocol	Port	Status
This section contains no values yet				

Role: New configuration name:

A picture above demonstrates default OpenVPN configurations list, which is empty, so you have to define a new configuration to establish any sort of OpenVPN connection. To create it, enter desired configuration name in **“New configuration name”** field, select device role from **“Role”** drop down list. For example, to create a OpenVPN client with configuration name Demo, select client role, name it **“Demo”** and press **“Add New”** button as shown in the following picture.



Role: New configuration name:

A new configuration entry has appeared in the list and it is populated with default OpenVPN client settings.

Tunnel Name	Tun/Tap	Protocol	Port	Status	
client_Demo	-	-	1194	Disabled	<input type="button" value="Edit"/> <input type="button" value="Delete"/>

(You could select a server in previous step to create server default configuration). To see at specific configuration settings press **“edit”** button located in newly created configuration entry. A new page with detailed configuration

appears, as shown in the picture below.

OpenVPN instance: 'client_Demo'

Main settings

Enable

Tun/Tap
 Type of used device

Protocol
 TCP/UDP port for both, local and remote

Port
 Use fast LZO compression

LZO
 Use fast LZO compression

Authentication

Remote host IP address

Resolve Retry

No Bind Do not bind to local address and port

Keep alive
 Helper directive to simplify the expression of --ping and --ping-restart

Client

Certificate authority

Client certificate

Client key

You can set custom settings here according to your VPN needs. Below is summary of parameters available to set:

	Field name	Explanation
1.	Enabled	Switches configuration on and off. This must be selected to make configuration active.
2.	TUN/TAP	Selects virtual VPN interface type. TUN is most often used in typical IP-level VPN connections, however, TAP is required to some Ethernet bridging configurations.
3.	Protocol	Defines a transport protocol used by connection. You can choose here between TCP and UDP.
4.	Port	defines TCP or UDP port number (make sure, that this port allowed by firewall).
5.	LZO	This setting enables LZO compression. With LZO compression, your VPN connection will generate less network traffic; however, this means higher router CPU loads. Use it carefully with high rate traffic or low CPU resources.
6.	Authentication	Sets authentication mode, used to secure data sessions. Two possibilities you have here: "Static" means, that OpenVPN client and server will use the same secret key, which must be uploaded to the router using "Static pre-shared key" option. "Tls" authentication mode uses X.509 type certificates. Depending on your selected OpenVPN mode (client or server) you have to upload these certificates to the router: For client: Certificate Authority (CA), Client certificate, Client key. For server: Certificate Authority (CA), Server certificate, Server key and Diffie-Hellman (DH) certificate used to key exchange through unsafe data networks. All mention certificates can be generated using OpenVPN or OpenSSL utilities on any type host machine. Certificate generation and theory is out of scope of this user manual.
7.	Remote host IP address	IP address of OpenVPN server (applicable only for client configuration).
8.	Resolve Retry	Sets time in seconds to try resolve server hostname periodically in case of first resolve failure before generating service exception.
9.	Keep alive	Defines two time intervals: one is used to periodically send ICMP request to OpenVPN server, and another one defines a time window, which is used to restart OpenVPN service, if no ICMP

		request is received during the window time slice.
10.	Local tunnel endpoint	IP address of virtual local network interface (applicable only for point to point connections).
11.	Remote tunnel endpoint	IP address of virtual remote network interface.
12.	Remote network IP address	IP address of remote virtual network.
13.	Remote network IP netmask	Subnet mask of remote virtual network.

After setting any of these parameters press **“Save”** button. Some of selected parameters will be shown in the configuration list table. You should also be aware of the fact that router will launch separate OpenVPN service for every configuration entry (if it is defined as active, of course) so the router has ability to act as server and client at the same time.

IPsec

The IPsec protocol client enables the router to establish a secure connection to an IPsec peer via the Internet. IPsec is supported in two modes - transport and tunnel. Transport mode creates secure point to point channel between two hosts. Tunnel mode can be used to build a secure connection between two remote LANs serving as a VPN solution.

IPsec system maintains two databases: Security Policy Database (SPD) which defines whether to apply IPsec to a packet or not and specify which/how IPsec-SA is applied and Security Association Database (SAD), which contain Key of each IPsec-SA.

The establishment of the Security Association (IPsec-SA) between two peers is needed for IPsec communication. It can be done by using manual or automated configuration.

Note: router starts establishing tunnel when data from router to remote site over tunnel is sent. For automatic tunnel establishment used tunnel keep alive feature.

Automatic IPsec Key exchange

Description

Enable IPsec

IPSec key exchange mode

Mode

Enable NAT traversal

Enable initial contact

My identifier type

My identifier

Preshare Key

(Length [6-32])

Remote VPN endpoint

IP address

	Field name	Description
1.	Enable IPsec	Check box to enable IPsec.
2.	IPsec key exchange mode	Automatic Key exchange.
3.	Enable NAT traversal	Enable this function if client-to-client applications will be used.
4.	Enable initial contact	Enable this to send an INITIAL-CONTACT message.
5.	Peers identifier type	Choose "fqdn" or "user fqdn" accordingly to your IPsec server configuration.
6.	Mode	Select "Main" or "Aggressive" mode accordingly to your IPsec server configuration.
7.	My identifier	Set the device identifier for IPsec tunnel.
8.	Preshare key	specify the authentication secret [string]. Secret's length depends on selected algorithm, eg. 128 bit long secret is 16 characters in length, 128 bits / 8 bits (one character) = 16.
9.	Remote VPN Endpoint	set remote IPsec server IP address.

Phase 1

Encryption

Hash

Dh group

Phase 2

PFS group

Encryption

Authentication

Remote network secure group

IP address

Subnet mask

[?](#) (Number [0-32])

Phase 1 and **Phase 2** must be configured accordingly to the IPsec server configuration.

Remote Network Secure Group – Set the remote network (Secure Policy Database) information.

Tunnel keep alive

Enable keep alive

Ping IP address

Ping period (seconds)

	Field name	Explanation
1.	Tunnel keep alive	Allows sending ICMP echo request (ping utility) to the remote tunnel network. This function may be used to automatically start the IPsec tunnel.
2.	Ping IP address	Enter IP address to which ICMP echo requests will be sent.
3.	Ping period (seconds)	Set sent ICMP request period in seconds.

GRE Tunnel

GRE (Generic Routing Encapsulation RFC2784) is a solution for tunneling RFC1812 private address-space traffic over an intermediate TCP/IP network such as the Internet. GRE tunneling does not use encryption it simply encapsulates data and sends it over the WAN.

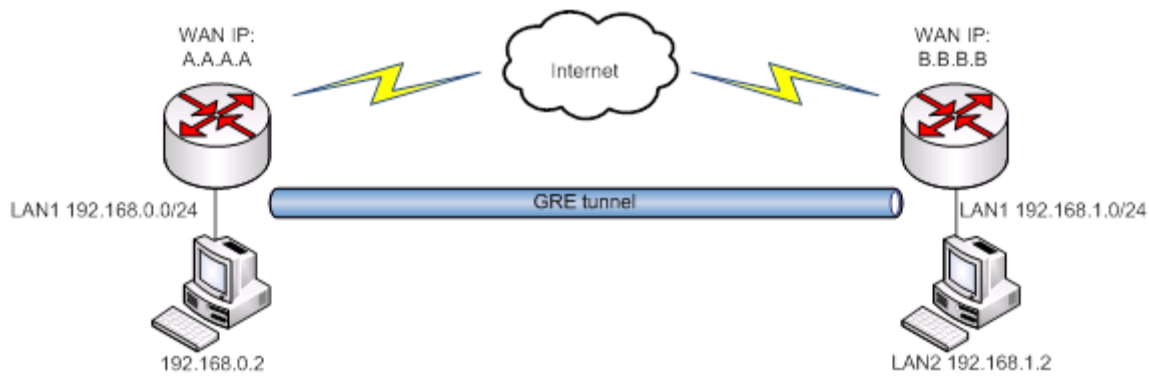

In the example network diagram two distant networks LAN1 and LAN2 are connected.

To create GRE tunnel the user must know the following parameters:

1. Source and destination IP addresses.
2. Tunnel local IP address
3. Distant network IP address and Subnet mask

Enable GRE Tunnel

TTL
 Value [0-255]

PMTUD

Remote tunnel network address

Remote CIDR
 CIDR (netmask) value [0-32]

Remote IP address

MTU
 MTU value [0-1500]

	Field name	Explanation
1.	Enable GRE Tunnel	Check the box to enable the GRE Tunnel function.
2.	TTL	Specify the fixed time-to-live (TTL) value on tunneled packets [0-255]. The 0 is a special value meaning that packets inherit the TTL value.
3.	PMTUD	Check the box to enable the Path Maximum Transmission Unit Discovery (PMTUD) status on this tunnel.
4.	Remote tunnel network address	Specify remote LAN Subnet address.
5.	Remote CIDR	Specify remote LAN Subnet CIDR value.
6.	Remote IP address	Specify remote WAN IP address.
7.	MTU	Specify the maximum transmission unit (MTU) of a communications protocol of a layer in bytes.

Systems

Configuration Wizard

The configuration wizard provides a simple way of quickly configuring the device in order to bring it up to basic functionality.

The wizard is comprised out of 4 steps and they are as follows:

Step 1 (Password change)

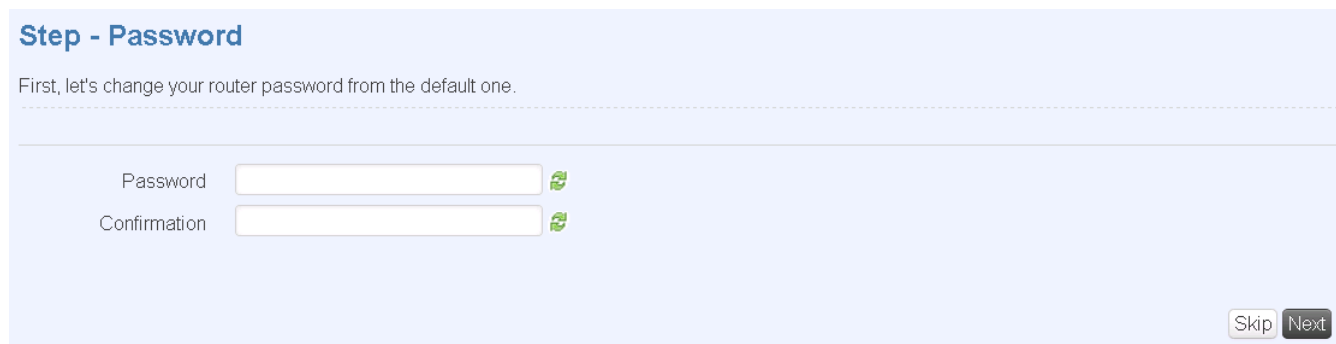

Step - Password

First, let's change your router password from the default one.

Password 

Confirmation 

First, the wizard prompts you to change the default password. Simply enter the same password into both Password and Confirmation fields and press **Next**.

Note: At this point you can also **Skip** the wizard.

Step 2 (LTE)

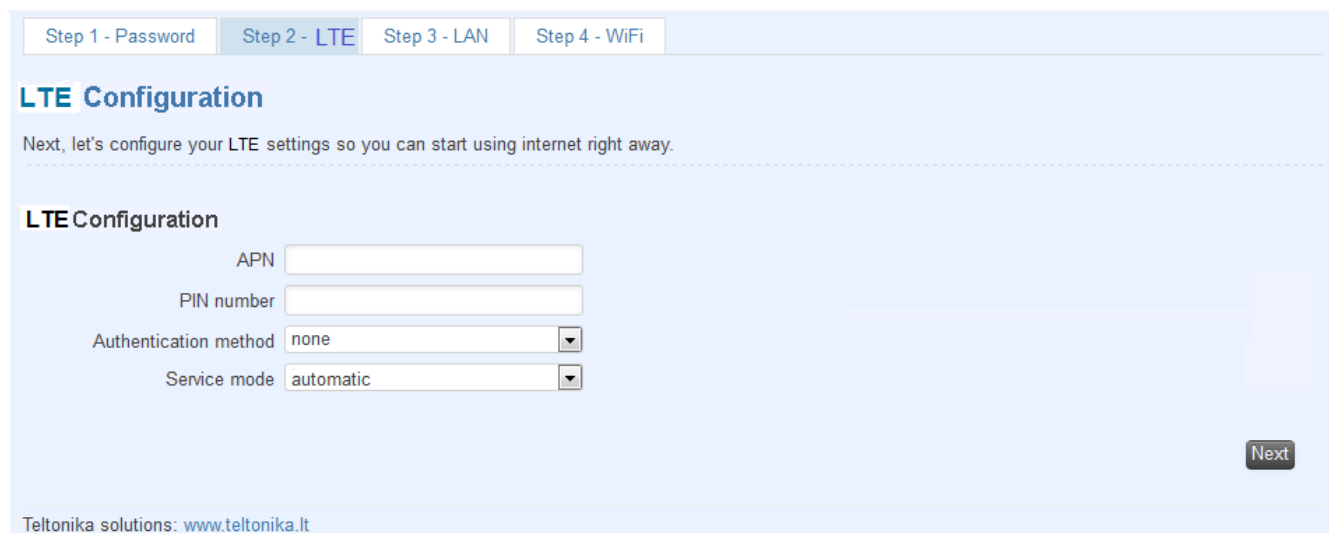

Step 1 - Password Step 2 - **LTE** Step 3 - LAN Step 4 - WiFi

LTE Configuration

Next, let's configure your LTE settings so you can start using internet right away.

LTE Configuration

APN

PIN number

Authentication method

Service mode

Teltonika solutions: www.teltonika.lt

Alternate model:

Step - LTE

Next, let's configure your **LTE** settings so you can start using internet right away.

LTE Configuration

APN

PIN number

Username

Password 

Preferred network 

Next

Teltonika solutions: www.teltonika.lt

Next we have to enter your LTE configuration. On a detailed instruction on how this should be done see the LTE Section under Network

Step 3 (LAN)

Step - LAN

Here we will configure the basic settings of a typical LAN configuration. The wizard will cover 2 basic configurations: static IP address LAN and DHCP client.

Common Configuration

Protocol 

IPv4 address

IPv4 netmask 

IPv4 gateway

IPv4 broadcast

Use custom DNS servers 

DHCP Server

Disable

Start

Limit

Leasetime

 Expiry time of leased addresses, minimum is 2 Minutes (2m).

Next

Next, you are given the chance to configure your LAN and DHCP server options. For a detailed explanation see LAN under Network.

Step 4 (Wifi)

Step - Wireless

Now let's configure your wireless radio. (Note: if you are currently connecting via wireless and you change parameters, like SSID, encryption, etc. your connection will be dropped and you will have to reconnect with a new set of parameters.)

Device Configuration

Wireless network is enabled
Important note: Do not disable if the only way to reach the router is your wireless network.

Channel:

Mode:

Country Code:

Interface Configuration

ESSID:

Hide ESSID:

Encryption:

Cipher:

Key:

Finish

The final step allows you to configure your wireless settings in order to set up a rudimentary Access Point.

When you're done with the configuration wizard, press **Finish**.

Administration

Administration properties

Administration password

	Field name	Explanation
1.	Password	Enter your new administration password.
2.	Confirmation	Re-enter your new administration password.

Important notes:

- The only way to gain access to the web management if you forget the administrator password is to reset the device factory default settings. Default administrator login settings are:

User Name: **admin**

Password: **admin01**

Logging

System logs are divided into following groups:

- Info
- Notice
- Warning
- Error
- Critical
- Alert

- Emergency

You can watch logs by choosing the group from dropdown list and clicking button “show”.

SSH Access control

	Field name	Explanation
1.	SSH Access	SSH can be enabled or disabled by choosing “Enable” or “Disable” from dropdown list.
2.	Port	Specify port for SSH access. Default port is 22.
3.	Remote SSH access	If check box is selected users can access the router via SSH from the outside (WAN). When check box is not selected users can access the router only from LAN.

Note: The router has 2 users: „admin“ for webUI and „root“ for SSH. When logging in via SSH use „root“.

Web Access control

	Field name	Explanation
1.	HTTP Web server port	specify a port number for routers web management via HTTP protocol. Default port is 80.
2.	Remote HTTP access	if check box is selected users can access the router via the HTTP WEB Interface from the outside (WAN). When check box is not selected users can access the router only from LAN.
3.	HTTPS server port	specify a port number for routers web management via HTTPS protocol. Default port is 443.
4.	Remote HTTPS access	if check box is selected users can access the router via the HTTPS WEB Interface from the outside (WAN). When check box is not selected users can access the router only from LAN.

Backup and Firmware

Router firmware backup, upgrade and settings reset to their factory defaults.

Backup and reset configuration

Backup archive – download current router settings file to personal computer.

Reset to defaults – reset router settings to their default values.

Restore configuration

Restore backup – upload and restore router settings file from personal computer.

Firmware upgrade

Keep settings – when check box is selected router will keep saved user configuration settings after firmware upgrade.

When check box is not selected all router settings will be restored to factory defaults after firmware upgrade.

Image – router firmware upgrade file.

Firmware upgrade - Verify

Firmware upgrade - Verify

The flash image was uploaded. Below is the checksum and file size listed, compare them with the original file to ensure data integrity. Click "Proceed" below to start the flash procedure.

- Checksum: 446e4c75bf7f558642aabb5b61f37f94
- Size: 4.38 MB (7.69 MB available)
- Configuration files will be kept.

Compare firmware file checksum to ensure data integrity. If checksum is correct click “Proceed” button below. Wait until upgrade process completes.

Important notes:

- Leaving “Keep settings” check box unselected before upgrade process will change IP address of router to default value 192.168.1.1 and you may need to configure router again (please read chapter “Logging in” at page 9)

Warning: Do not ever remove router power supply and do not press reset button during upgrade process! This will totally damage your router and it won't be accessible. If you have any problems related to firmware upgrade you should always consult with local dealer.

Reboot

Reboot router by pressing button “Reboot”.

Logout

Log out from router management WEB interface.

Glossary:

WAN – Wide Area Network is a telecommunication network that covers a broad area (i.e., any network that links across metropolitan, regional, or national boundaries). Here we use the term WAN to mean the external network that the router uses to reach the internet.

LAN – A local area network (LAN) is a computer network that interconnects computers in a limited area such as a home, school, computer laboratory, or office building.

DHCP – The Dynamic Host Configuration Protocol (DHCP) is a network configuration protocol for hosts on Internet Protocol (IP) networks. Computers that are connected to IP networks must be configured before they can communicate with other hosts. The most essential information needed is an IP address, and a default route and routing prefix. DHCP eliminates the manual task by a network administrator. It also provides a central database of devices that are connected to the network and eliminates duplicate resource assignments.

ETHERNET CABLE – Refers to the CAT5 UTP cable with an RJ-45 connector. In other words: the most common internet cable ever.



AP – Access point. An access point is any device that provides wireless connectivity for wireless clients. In this case, when you enable Wi-Fi on your router, your router becomes an access point.



DNS – Domain Name Resolver. A server that translates names such as www.google.it to their respective IPs. In order for your computer or router to communicate with some external server it needs to know it's IP, its name "www.something.com" just won't do. There are special servers set in place that perform this specific task of resolving names into IPs, called Domain Name servers. If you have no DNS specified you can still browse the web, provided that you know the IP of the website you are trying to reach.